

HP 16520A/16521A

PATTERN GENERATION MODULE

Service Manual

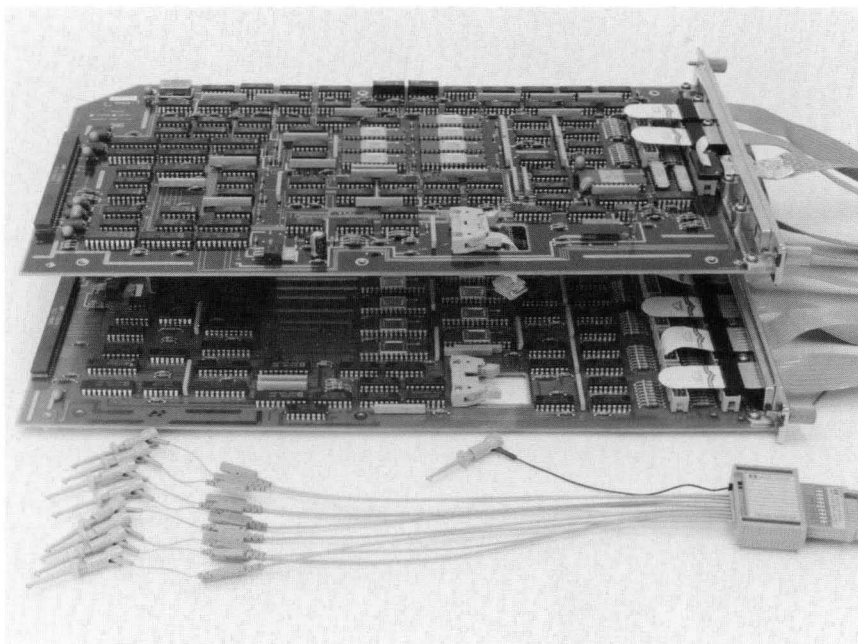



**HEWLETT
PACKARD**



SERVICE MANUAL

**HP 16520A 50 MBit/s
Pattern Generator Master Card
AND
HP 16521A 50 MBit/s
Pattern Generator Expansion Card**

© COPYRIGHT HEWLETT-PACKARD COMPANY/COLORADO DIVISION 1987
1900 GARDEN OF THE GODS ROAD, COLORADO SPRINGS, COLORADO U.S.A.

ALL RIGHTS RESERVED

Manual Part No. 16520-90901
Microfiche Part No. 16520-90801

PRINTED: SEPTEMBER 1987

CERTIFICATION

Hewlett-Packard Company certifies that this product met its published specifications at the time of shipment from the factory. Hewlett-Packard further certifies that its calibration measurements are traceable to the United States National Bureau of Standards, to the extent allowed by the Bureau's calibration facility, and to the calibration facilities of other International Standards Organization members.

WARRANTY

This Hewlett-Packard product is warranted against defects in material and workmanship for a period of one year from date of shipment. During the warranty period, Hewlett-Packard Company will, at its option, either repair or replace products which prove to be defective.

For warranty service or repair, this product must be returned to a service facility designated by HP. Buyer shall prepay shipping charges to HP and HP shall pay shipping charges to return the product to Buyer. However, Buyer shall pay all shipping charges, duties, and taxes for products returned to HP from another country.

HP warrants that its software and firmware designated by HP for use with an instrument will execute its programming instructions when properly installed on that instrument. HP does not warrant that the operation of the instrument or software, or firmware will be uninterrupted or error free.

LIMITATION OF WARRANTY

The foregoing warranty shall not apply to defects resulting from improper or inadequate maintenance by Buyer, buyer-supplied software or interfacing, unauthorized modification or misuse, operation outside the environmental specifications for the product, or improper site preparation or maintenance.

NO OTHER WARRANTY IS EXPRESSED OR IMPLIED. HP SPECIFICALLY DISCLAIMS THE IMPLIED WARRANTIES OF MERCHANTABILITY AND FITNESS FOR A PARTICULAR PURPOSE.

EXCLUSIVE REMEDIES

THE REMEDIES PROVIDED HEREIN ARE BUYER'S SOLE AND EXCLUSIVE REMEDIES. HP SHALL NOT BE LIABLE FOR ANY DIRECT, INDIRECT, SPECIAL, INCIDENTAL, OR CONSEQUENTIAL DAMAGES, WHETHER BASED ON CONTRACT, TORT, OR ANY OTHER LEGAL THEORY.

ASSISTANCE

Product maintenance agreements and other customer assistance agreements are available for Hewlett-Packard products.

For any assistance, contact your nearest Hewlett-Packard Sales and Service Office. Addresses are provided at the back of this manual.

SAFETY CONSIDERATIONS

GENERAL - This is a Safety Class I instrument (provided with terminal for protective earthing).

OPERATION - BEFORE APPLYING POWER verify that the power transformer primary is matched to the available line voltage, the correct fuse is installed, and Safety Precautions are taken (see the following warnings). In addition, note the instrument's external markings which are described under "Safety Symbols."

WARNING

- o Servicing instructions are for use by service-trained personnel. To avoid dangerous electric shock, do not perform any servicing unless qualified to do so.
- o **BEFORE SWITCHING ON THE INSTRUMENT**, the protective earth terminal of the instrument must be connected to the protective conductor of the (mains) powercord. The mains plug shall only be inserted in a socket outlet provided with a protective earth contact. The protective action must not be negated by the use of an extension cord (power cable) without a protective conductor (grounding). Grounding one conductor of a two-conductor outlet is not sufficient protection.
- o If this instrument is to be energized via an auto-transformer (for voltage reduction) make sure the common terminal is connected to the earth terminal of the power source.
- o Any interruption of the protective (grounding) conductor (inside or outside the instrument) or disconnecting the protective earth terminal will cause a potential shock hazard that could result in personal injury.
- o Whenever it is likely that the protection has been impaired, the instrument must be made inoperative and be secured against any unintended operation.
- o Only fuses with the required rated current, voltage, and specified type (normal blow, time delay, etc.) should be used. Do not use repaired fuses or short circuited fuseholders. To do so could cause a shock or fire hazard.
- o Do not operate the instrument in the presence of flammable gasses or fumes. Operation of any electrical instrument in such an environment constitutes a definite safety hazard.

- o Do not install substitute parts or perform any unauthorized modification to the instrument.
- o Adjustments described in the manual are performed with power supplied to the instrument while protective covers are removed. Energy available at many points may, if contacted, result in personal injury.
- o Any adjustment, maintenance, and repair of the opened instrument under voltage should be avoided as much as possible, and when inevitable, should be carried out only by a skilled person who is aware of the hazard involved.
- o Capacitors inside the instrument may still be charged even if the instrument has been disconnected from its source of supply.

SAFETY SYMBOLS



Instruction manual symbol. The product will be marked with this symbol when it is necessary for the user to refer to the instruction manual in order to protect against damage to the product.



Indicates hazardous voltages.



Earth terminal (sometimes used in manual to indicate circuit common connected to grounded chassis).

WARNING

The WARNING sign denotes a hazard. It calls attention to a procedure, practice, or the like, which, if not correctly performed or adhered to, could result in personal injury. Do not proceed beyond a WARNING sign until the indicated conditions are fully understood and met.

CAUTION

The CAUTION sign denotes a hazard. It calls attention to an operating procedure, practice, or the like, which, if not correctly performed or adhered to, could result in damage to or destruction of part or all of the product. Do not proceed beyond a CAUTION sign until the indicated conditions are fully understood or met.

TABLE OF CONTENTS

SECTION	PAGE
I. GENERAL INFORMATION	1-1
1-1. Introduction	1-1
1-2. Modules Covered By Manual	1-1
1-3. Safety Requirements	1-1
1-4. Product Description	1-2
1-5. Accessories Supplied	1-2
1-6. Accessories Available	1-2
1-7. Specifications	1-2
1-8. Operating Characteristics	1-2
1-9. Recommended Test Equipment	1-2
II. INSTALLATION	2-1
2-1. Introduction	2-1
2-2. Initial Inspection	2-1
2-3. Preparation For Use	2-1
2-4. Power Requirements	2-1
2-5. Safety Requirements	2-1
2-6. Probe Cable Replacement	2-1
2-7. Installation	2-1
2-8. Module Installation	2-2
2-9. Adding Expansion Cards	2-8
2-10. Operating Environment	2-10
2-11. Storage	2-10
2-12. Packaging	2-10
2-13. Tagging For Service	2-10
III. PERFORMANCE TESTS	3-1
3-1. Introduction	3-1
3-2. Recommended Test Equipment	3-1
3-3. Test Record	3-1
3-4. Performance Test Interval	3-1
3-5. Performance Test Procedures	3-1
3-6. Data Period Accuracy Test	3-2
3-7. Duty Cycle Test	3-8

SECTION	PAGE
IV. ADJUSTMENTS	4-1
4-1. Introduction	4-1
4-2. Calibration Interval	4-1
4-3. Safety Requirements	4-1
4-4. Recommended Test Equipment	4-1
4-5. Extender Board Installation	4-1
4-6. Instrument Warmup	4-4
4-7. Adjustment And Calibration Check	4-4
V. REPLACEABLE PARTS	5-1
5-1. Introduction	5-1
5-2. Abbreviations	5-1
5-3. Replaceable Parts List	5-1
5-4. Exchange Assemblies	5-1
5-5. Ordering Information	5-1
5-6. Direct Mail order System	5-2
VI. SERVICE.....	6-1
6-1. Introduction	6-1
6-2. Safety Requirements	6-1
6-3. Recommended Test Equipment	6-1
6-4. Module Block Diagram and Theory Of Operation	6-1
6-5. Pattern Generator Master Card Theory of Operation	6-3
6-6. Expansion Card Theory Of Operation	6-4
6-7. Self Tests	6-5
6-8. Troubleshooting	6-9
6-9. Card Replacement	6-32
6-10. Probe Cable Replacement	6-35

LIST OF TABLES

TABLE	TITLE	PAGE
1-1.	HP 16520/21A Specifications	1-3
1-2.	HP 16520/21A Operating Characteristics	1-4
1-3.	Recommended Test Equipment	1-8
3-1.	Performance Test Record	3-13
5-1.	Reference Designators and Abbreviations	5-3
5-2.	Replaceable Parts	5-4

LIST OF ILLUSTRATIONS

FIGURE	TITLE	PAGE
2-1.	Installation Guide	2-2
2-2.	Endplate Overlap	2-3
2-3.	One Master and One Expansion Card	2-4
2-4.	One Master and Two Expansion Cards	2-4
2-5.	One Master and three Expansion Cards	2-5
2-6.	One Master and Four Expansion Cards	2-5
2-7.	Cable End	2-6
2-8.	Cable Position	2-6
2-9.	Endplate Overlap	2-7
2-10.	Endplate Overlap	2-9
2-11.	Configuration Guide	2-9
3-1.	Data Period Accuracy Test Equipment Hookup	3-2
3-2.	Startup Screen	3-3
3-3.	Clock Field	3-3
3-4.	Clock Period Screen	3-4
3-5.	Channel Assignment Field	3-4
3-6.	Data Channel Select	3-4
3-7.	Program Field	3-5
3-8.	Numeric Entry	3-5
3-9.	Insert New Program Line	3-5
3-10.	Program Field	3-6
3-11.	Numeric Entry	3-6
3-12.	Example Program	3-6
3-13.	Run Repetitive Mode	3-7
3-14.	Duty Cycle Test Equipment Hookup	3-8
3-15.	Startup Screen	3-9
3-16.	Set TTL Level	3-9
3-17.	Clock Field	3-9
3-18.	Divide By 1 Field	3-10
3-19.	Channel Assignment Field	3-10
3-20.	Data Output Select	3-10
3-21.	Example Program	3-11
3-22.	Run Repetitive Mode	3-11
3-23.	25 MHz Square Wave	3-11

LIST OF ILLUSTRATIONS

FIGURE	TITLE	PAGE
4-1.	Card Endplate Overlap	4-2
4-2.	Extender Board and Module	4-3
4-3.	Adjustment Pot Location	4-4
4-4.	Startup Screen	4-5
4-5.	Delete Field	4-5
4-6.	Program Line Field	4-6
4-7.	User Defined Field	4-6
4-8.	Internal Clock	4-6
4-9.	Period Selection	4-7
4-10.	Run Single Selection	4-8
6-1.	HP 16520/21A Pattern Generator Block Diagram	6-1
6-2.	Pattern Generator Master Card Block Diagram	6-2
6-3.	Expansion Card Block Diagram	6-2
6-4.	Startup Screen	6-5
6-5.	Load Test System	6-6
6-6.	Test System Screen	6-6
6-7.	Main Test Menu	6-7
6-8.	Clock Rate Test Run Screen	6-7
6-9.	Stop Field	6-8
6-10.	Exit Test System	6-8
6-11.	Troubleshooting Flow Chart	6-10
6-12.	Endplate Overhang	6-32
6-13.	Cable End	6-33
6-14.	Cable Position	6-33
6-15.	Endplate Overhang	6-34
6-16.	Endplate Overhang	6-35
6-17.	Card On Antistatic Mat	6-36
6-18.	Retainer And Screws	6-36
6-19.	Card Connectors	6-37

TABLE OF CONTENTS

GENERAL INFORMATION

- 1-1. Introduction 1-1
- 1-2. Modules Covered By Manual 1-1
- 1-3. Safety Requirements 1-1
- 1-4. Product Description 1-2
- 1-5. Accessories Supplied 1-2
- 1-6. Accessories Available 1-2
- 1-7. Specifications 1-2
- 1-8. Operating Characteristics 1-2
- 1-9. Recommended Test Equipment 1-2

SECTION I GENERAL INFORMATION

1-1. INTRODUCTION

This service manual contains information for testing, adjusting, and servicing the HP 16520A 50 MBit/s Pattern Generator Card, and the HP 16521A 50 MBit/s Pattern Generator Expansion Card. This manual is divided into six sections as follows:

- I - General Information
- II - Installation
- III - Performance Tests
- IV - Adjustments
- V - Replaceable Parts
- VI - Service

Information for operating, programming, and interfacing the HP 16520A/16521A Pattern Generator Module is contained in the HP 16520/16521A Pattern Generator Operating and Programming Manual supplied with each module.

The General Information Section includes safety requirements, a product description, and a list of accessories supplied and of accessories available. Also included are tables listing specifications and operating characteristics, and a list of recommended test equipment.

Listed on the title page of this manual is a Microfiche part number. This number can be used to order 4 X 6 inch microfilm transparencies of the manual. Each microfiche contains up to 96 photo-duplicates of the manual pages. The microfiche package also includes the latest Manual Changes supplement as well as pertinent Service Notes.

To complete the service documentation for your system, place this service manual in the 3-ring binder with your Logic Analysis System Mainframe Service Manual.

1-2. MODULES COVERED BY THIS MANUAL

The information covered in this manual is for the HP 16520A/16521A Pattern Generator Module. If either of the two cards in the module have changed, a new card number will be assigned and the manual will be accompanied by a Manual Changes Supplement. This supplement explains the changes and how to adapt the manual to the newer card.

In addition to the change information, the supplement may contain information for correcting errors in the manual. To keep this manual as current and accurate as possible, Hewlett-Packard recommends that you periodically request the latest Manual Changes Supplement.

1-3. SAFETY REQUIREMENTS

Specific warnings, cautions, and instructions are placed wherever applicable throughout the manual. These must be observed during all phases of operation, service, and repair of the module. Failure to comply with them violates safety standards of design, manufacture, and intended use of this module. Hewlett-Packard assumes no liability for the failure of the customer to comply with these safety requirements.

1-4. PRODUCT DESCRIPTION

The HP 16520A/16521A Pattern Generator Module is a general purpose digital stimulus. The module consists of one master card or one master card and one or more expansion cards. The HP 16520A master card offers the minimum configuration of 12 data and three strobe channels, a clock out channel and three dedicated input qualifier channels.

The HP 16521A Expansion Card offers expandability with 48 additional data out channels. Up to four expansion boards (192 channels) can be connected to a single master board. Some of the module's main features are:

- Three strobe output channels (10 ns minimum resolution)
- Three input qualifier channels, and one input clock
- 50 MBit/s programmable pattern generation
- 4 k bit per channel memory depth
- Expandable to 204 data out channels (1 HP 16520A and 4 HP 16521As)
- TTL and ECL interface levels
- Internally available clock rates between 5 kHz and 50 MHz
- Intermodule trigger capability

1-5. ACCESSORIES SUPPLIED

The following accessories are supplied with the HP 16520A/16521A Pattern Generator Module. Quantity one unless shown otherwise.

HP 16520A:

- Operating and Programming Manual Set
- Service Manual
- Lead Set Qty 2 (HP 10347A purple tip)
- Input Qualifier Probe Kit (HP 16520-69501 grey tip)

- Intercard Connecting Cable Kit (HP 16521-88701)
- Input Qualifier Probe Cable (HP 16520-61601)
- 8 Channel Data Probe Cable (HP 16520-61602)
- Clock Probe Cable (HP 16520-61603)

HP 16521A:

- 8 Channel Data Probe Cables (HP 16520-61602) Qty 6

1-6. ACCESSORIES AVAILABLE

- 8 Channel ECL Differential Driver Pod (HP 10345A)
- 8 Channel TTL Tristate Buffer Pod (HP 10346A)
- Grabbers (HP 5959-0288 Qty 20)
- Service Data Supplement (16520-90903)

1-7. SPECIFICATIONS

Module specifications are listed in table 1-1. These specifications are the performance standards against which the module is tested.

1-8. OPERATING CHARACTERISTICS

Table 1-2 lists the module operating characteristics. The operating characteristics are not specifications, but are typical operating characteristics included as additional information for the user.

1-9. RECOMMENDED TEST EQUIPMENT

Equipment for testing and maintaining the HP 16520A/16521A Pattern Generator Module is listed in table 1-3. Other equipment may be substituted if it meets or exceeds the critical specifications listed in the table.

Table 1-1. HP 16520/21A Specifications.

HP 16520A/21A SPECIFICATIONS**CLOCK SOURCES** (HP 16520A ONLY)**INTERNAL CLOCK**

Clock Period: Programmable from 20 ns to 200 μ s in a 1-2-5 sequence.

Data Period Accuracy: $\pm 2\%$ (of period) ± 1 ns

EXTERNAL CLOCK (provided by user)

Input Clock Period:

1 Hz to 50 MHz (20 ns min period) ECL or TTL, internal frequency divide ($/1$, $/5$, or $/10$) provided.

Duty cycle: 10 ns minimum high time, 10 ns minimum low time

STROBES (HP 16520A ONLY)

Number of Strokes: 3 (ECL or TTL)

Bits/Channel: 4095

Maximum Bit Rate: 20 MBit/s (50 ns Period)

Edge Placement:

≤ 10 MBits/s: tenths of period
 > 10 MBits/s to 20 MBits/s: fifths of Period
 (DELAY + WIDTH \leq PERIOD)

Minimum delay is $0/10$ ($0/5$), maximum delay is $9/10$ ($4/5$) data period.
 Minimum width is $1/10$ ($1/5$) of data period, maximum width is the data period (values in parentheses apply to 20 MBits/s timebase setting).

If strobes are desired while operating with external clock, the data rate will be divided to $1/5$ or $1/10$ the external clock rate.

Table 1-2. HP 16520/21A Operating Characteristics

HP 16520/21A OPERATING CHARACTERISTICS

OUTPUT

Eight channel pods can be assigned as either standard ECL or TTL levels.
All characteristics are valid at the probe tip.

PARAMETER	ECL	TTL
VOH (steady state) VOL (steady state)	- 0.98V - 1.55V	2.7V 0.6V
Risetime/ Falltime (typ)	2.3 ns (-0.98 V to -1.55 V)	2.5 ns (0.6 V to 2.7 V)
Channel-to- channel Skew* (same card)	<= 5 ns	<= 5 ns
Channel-to- channel Skew* (card-to-card)	<10 ns	<10 ns
No. of std loads	3 (10 KH ECL, @ Vnh=150 mV)	3 (LSTTL, @ Vn1=250 mV)

(Output measurements made into a load consisting of 10 kΩ in series shunted with 10 pF to ground.)

(*) Skew measured at (+1.6 V) TTL and (-1.3 V) ECL levels.

Table 1-2. HP 16520/21A Operating Characteristics (cont.)

DATA CAPACITY

PARAMETER	HP 16520A	HP 16521A
Number Data Channels	12	48
Bits Per Channel	4095	4095
Maximum Bit Rate	50 MBit/s NRZ (20 ns Period)	50 MBit/s NRZ (20 ns Period)

INPUT (HP 16520A only)

Maximum Input Voltage: $\pm 40V$

Input Impedance: 100 k Ω , 8 pF

External Clock-in to Clock-out delay: 50 ns

PARAMETER	ECL	TTL
Vih (min)	-0.91V	2.08V
Vi1 (max)	-1.69V	1.12V

Table 1-2. HP 16520/21A Operating Characteristics (cont.)

EDITING FUNCTION

Program Listing: DELETE, MERGE , COPY, INSERT

LISTING BASES

Binary, octal, decimal, hexadecimal, and symbol

STEP MODE

Single-step program execution in 1 to 999 program line steps, from a break.

DATA INSTRUCTION SET

BREAK: Stops program execution, last data vector is held at output.

REPEAT: Repeats vector up to 256 times.

WAIT IMB: Wait for intermodule trigger.

WAIT EXTERNAL:

Wait for user-defined 3-bit pattern on external input pod to become true. No data cycle latency when pattern is true between 30 ns and 0 ns before next clock edge.

SIGNAL IMB:

Arms other measurement cards.

MACRO:

Four different macros may be defined and inserted as needed. Six character labels may be defined for each macro. Macros contain REPEAT, WAIT EXTERNAL, WAIT IMB, BREAK, and SIGNAL IMB instructions.

Table 1-2. HP 16520/21A Operating Characteristics (cont.)

CURRENT DRAW PER CARD

HP 16520A: 0.7 amp @ 5V

HP 16521A: 0.8 amp @ 5V

OPERATING ENVIRONMENT

Temperature:

Instrument, 0 degrees to 55 degrees C (+32 degrees to 131 degrees F).
Probe lead sets and cables, 0 degrees to 65 degrees C (+32 degrees to 149 degrees F).

Humidity:

Instrument, up to 95% relative humidity at +40 degrees C (+104 degrees F).

Altitude: To 4600 m (15,000 ft).

Vibration:

Operation: Random vibration 5-500 Hz, 10 minutes per axis, ~0.3 g (rms).

Non-operating:

Random vibration 5-500 Hz, 10 minutes per axis, ~ 2.41 g (rms); and swept sine resonant search, 5-500 Hz, 0.75 g (0-peak), 5 minute resonant dwell @ 4 resonances per axis.

Table 1-3. Recommended Test Equipment.

INSTRUMENT	CRITICAL SPECIFICATIONS	RECOMMENDED MODEL	USE*
Oscilloscope	200 MHz Bandwidth	HP 54201A	P,T
Multimeter	3 1/2 digit Resolution	HP 3468A	A
BNC Adapter	Qty 2	HP 1250-1032	P
50 Ohm Feedthru	Qty 1	HP 10100C	P
Probe Lead Set	Qty 2	HP 10347A	P
Grabbers	Qty 4	HP 6969-0288	P
Pulse Generator	100 KHz Repetition Rate Overshoot: 5% of Amp.	HP 8161A	P
Extender Board	No Substitute	HP 16500-69004	A,T
BNC Cable	(m-to-m) 9 inch (Qty2)	HP 10502A	P
* P=Performance Tests A=Adjustments T=Troubleshooting			

TABLE OF CONTENTS

INSTALLATION

2-1. Introduction	2-1
2-2. Initial Inspection	2-1
2-3. Preparation For Use	2-1
2-4. Power Requirements	2-1
2-5. Safety Requirements	2-1
2-6. Probe Cable Installation	2-1
2-7. Installation	2-1
2-8. Module Installation	2-2
2-9. Adding Expansion Cards	2-8
2-10. Operating Environment	2-10
2-11. Storage	2-10
2-12. Packaging	2-10
2-13. Tagging For Service	2-10

SECTION II INSTALLATION

2-1. INTRODUCTION

This section explains, how to initially inspect the HP 16520/21A Pattern Generator Module, how to prepare it for use, storage and shipment. Also included are procedures for module installation.

2-2. INITIAL INSPECTION

Inspect the shipping container for damage. If the shipping container or cushioning material is damaged, it should be kept until the contents of the shipment have been checked for completeness and the module has been checked mechanically and electrically. The contents of the shipment should be as listed in the "ACCESSORIES SUPPLIES" paragraph located in Section I.

Procedures for checking electrical performance are in Section III. If the contents of the container are incomplete, there is mechanical damage or defect, or the instrument does not pass the performance tests, notify the nearest Hewlett-Packard office.

If the shipping container is damaged, or the cushioning material shows signs of stress, notify the carrier as well as the Hewlett-Packard office. Keep the shipping material so the carrier can inspect it. The Hewlett-Packard office will arrange for repair or replacement at Hewlett-Packard's option without waiting for claim settlement.

2-3. PREPARATION FOR USE

WARNING

Read the Safety Considerations in the front of this manual and in Section I before installing or operating this module.

2-4. POWER REQUIREMENTS

All power supplies required for operating the HP 16520/21A Pattern Generator Module are supplied to the module through the backplane connector.

2-5. SAFETY REQUIREMENTS

Specific warnings, cautions, and instructions are placed wherever applicable throughout the manual. These must be observed during all phases of operation, service, and repair of the module. Failure to comply with them violates safety standards of design, manufacture, and intended use of this module. Hewlett-Packard assumes no liability for the failure of the customer to comply with these safety requirements.

2-6. PROBE CABLE INSTALLATION

The HP 16520/21A Pattern Generator Module comes with probe cables installed by the factory. If a cable is to be switched between TTL and ECL, refer to "PROBE CABLE REPLACEMENT" in Section VI of this manual.

2-7. INSTALLATION

CAUTION

Do not install, remove or replace the module in the instrument unless the instrument power is turned off.

The HP16520A Pattern Generator Card will take up one slot in the card cage. For every HP 16521A Expansion Card you connect to the HP 16520A Pattern Generator Card you will need an additional slot. A maximum of four expansion cards may be connected to the HP 16520A Pattern Generator Card. Installation procedures for the module and additional expansion cards are shown step-by-step in paragraphs 2-6 and 2-7.

2-8. MODULE INSTALLATION

If you are installing the HP 16520/21A Pattern Generator Module (one master card or one master card and one or more expansion cards), follow this procedure. If you are adding more expansion cards to an existing module, follow the procedure "ADDING EXPANSION CARDS" in paragraph 2-9.

CAUTION

The effects of ELECTROSTATIC DISCHARGE can damage electronic components. Use grounded wriststraps and mats when performing any kind of service to this module.

INSTALLATION CONSIDERATIONS:

- Cards or filler panels below the empty slots intended for the module installation do not have to be removed.
- You will need only one intercard connecting cable for any installation configuration.
- If previously installed modules prevent proper installation, they must be repositioned in the card cage. See figure 2-1.
- To maintain the channel-to-channel skew and adequate intercard signal quality, the shortest intercard connecting cable should be used and the expansion cards should be no more than two slots away from the master card. See figure 2-1.

Figure 2-1 is a guide in choosing the correct intercard connecting cable and illustrates the expansion card position relative to the master card. Use this guide at step d in the following procedure.

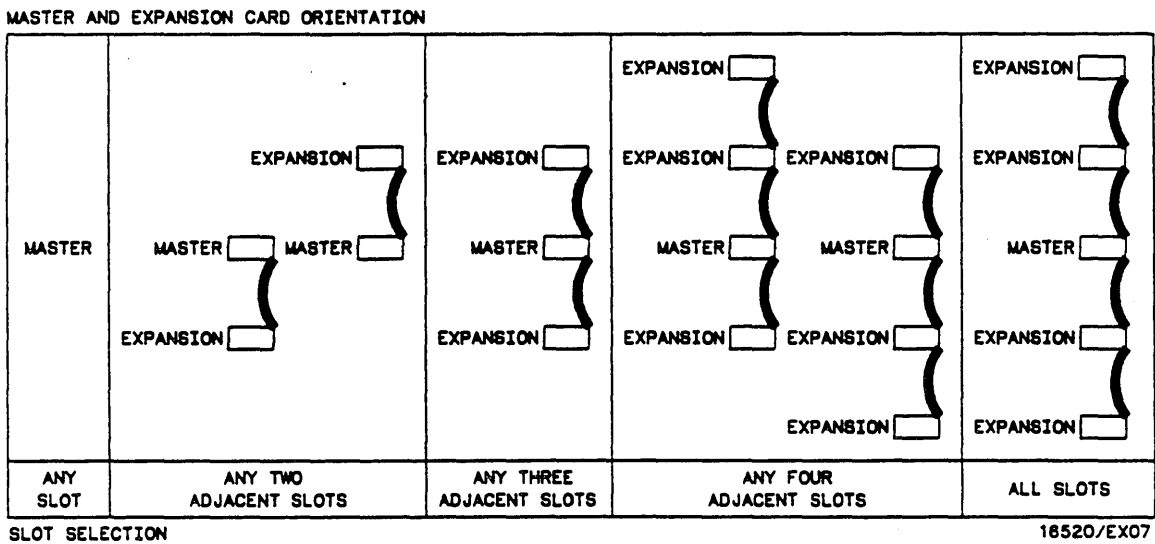

Figure 2-1. Installation Guide

PROCEDURE:

- a. Turn instrument power switch off, unplug power cord and disconnect any input or output connections.
- b. Starting from the top, loosen thumb screws on filler panel(s) and card(s).
- c. Starting from the top, begin pulling card(s) and filler panel(s) out half way. See figure 2-2.

CAUTION

All multi-card modules will be cabled together. Care should be taken to pull these cards out together.

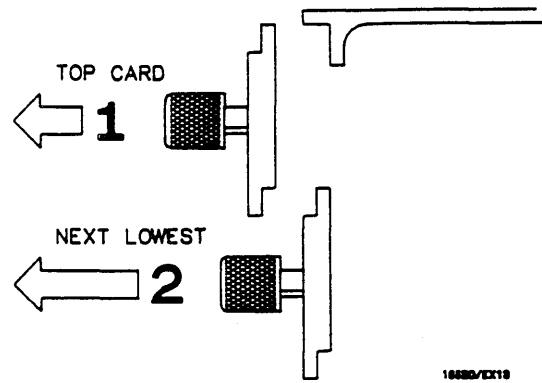

Figure 2-2. Endplate Overlap

- d. If the module consists of one master card, this card can be installed in any available slot. If the module consists of multiple cards, use figure 2-1 and figures 2-3 through 2-6 to plan your card configuration.

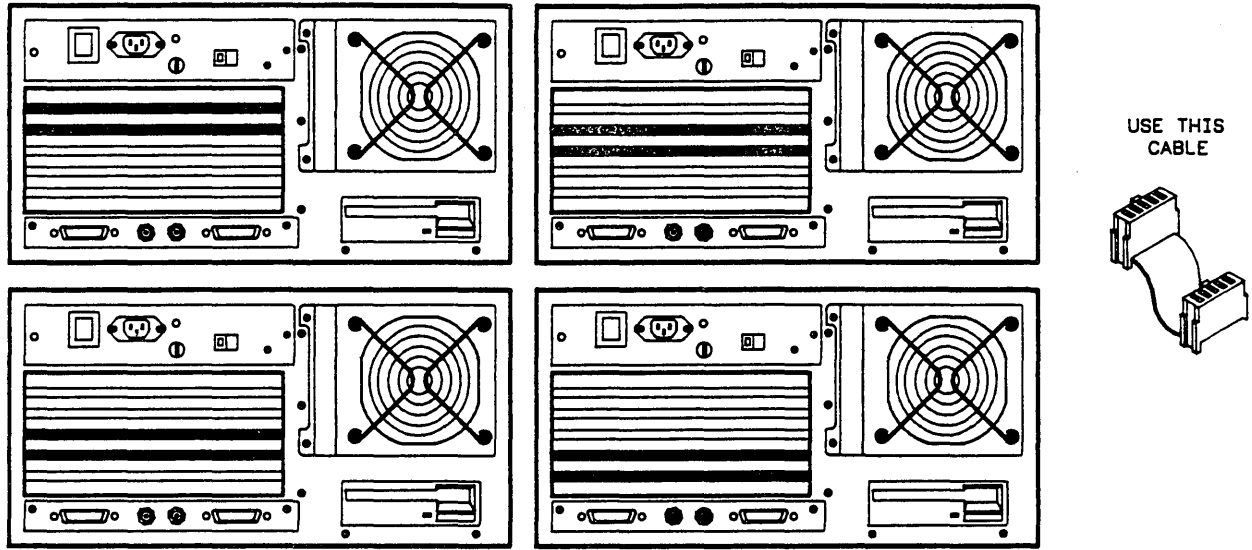

Figure 2-3. One Master and One Expansion Card

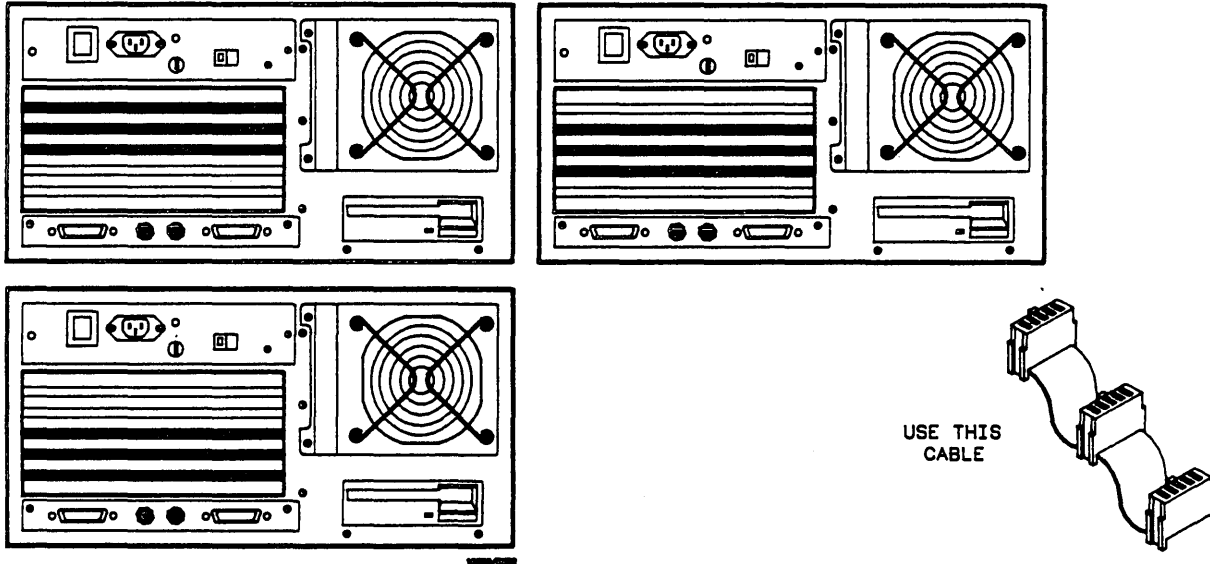

Figure 2-4. One Master and Two Expansion Cards

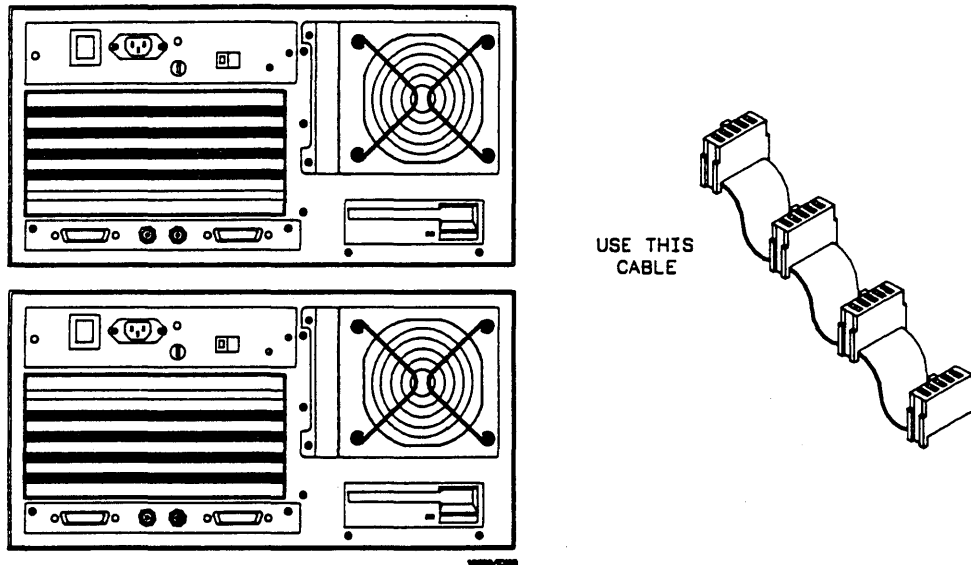

Figure 2-5. One Master and Three Expansion Cards

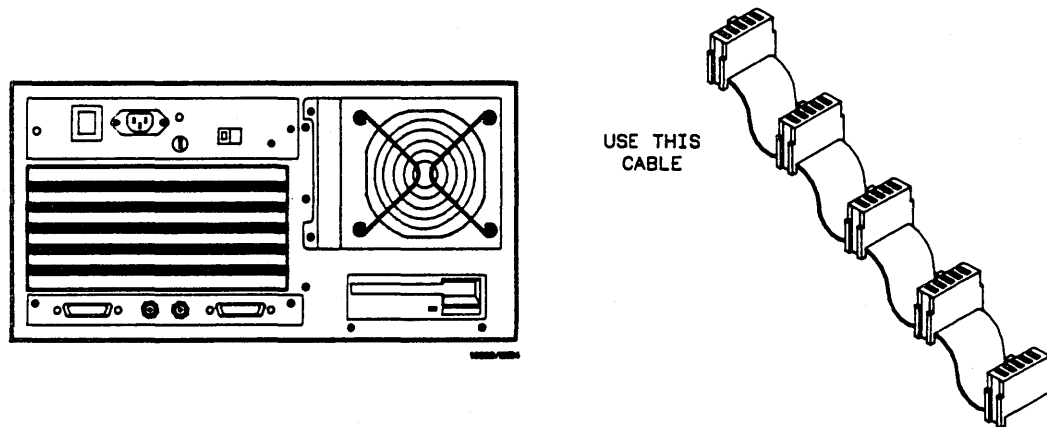

Figure 2-6. One Master and Four Expansion Cards

- e. Insert correct end of appropriate intercard connecting cable into connector on bottom card of configuration. See figure 2-7.
- f. Lay cable flat and pointing out to the rear of card. See figure 2-8.

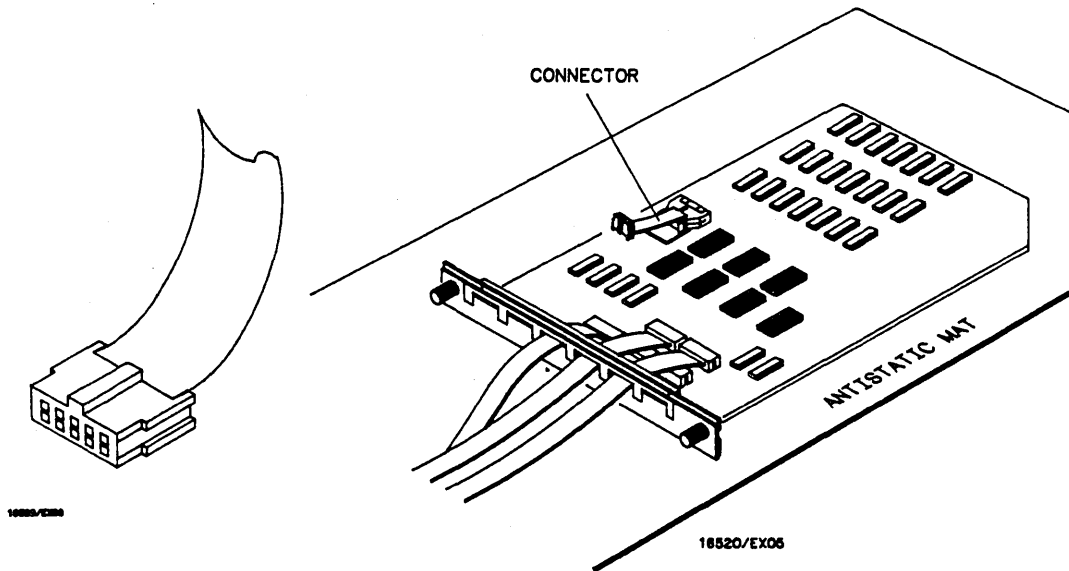

Figure 2-7. Cable End

Figure 2-8. Cable Position

- g. Slide card approximately **half way** into lowest slot that you are using for this installation.
- h. Slide next card **half way** into next highest slot, feeding the intercard connecting cable up through the hole.
- i. Insert appropriate connector into second card.
- j. If there are more cards to install, repeat steps h through i until all cards are in place.

- k. Firmly seat bottom card into backplane connector. **Keep applying pressure to the center of card endplate while tightening thumb screws finger tight.**
- l. Repeat for all cards and filler panels in a **bottom to top** order. See figure 2-9.

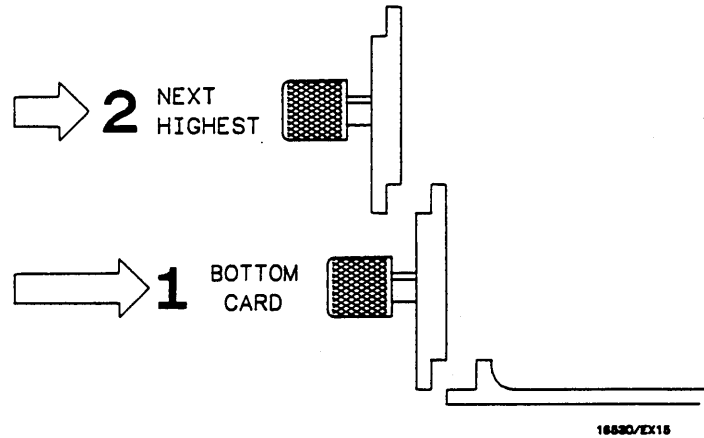

Figure 2-9. Endplate Overlap

- m. Any filler panels that are not used should be kept for future use. Filler panels **must** be installed in all unused card slots for correct air circulation.

2-9. ADDING EXPANSION CARDS

This procedure should be used if you are adding expansion cards to a previously installed pattern generator module.

CAUTION

The effects of ELECTROSTATIC DISCHARGE can damage electronic components. Use grounded wriststraps and mats when performing any kind of service to this module.

INSTALLATION CONSIDERATIONS:

- Cards or filler panels below the empty slots intended for the module installation do not have to be removed.
- You will only need one intercard connecting cable for any installation configuration.
- If previously installed modules prevent proper installation, they must be repositioned in the card cage. See figure 2-11.
- To maintain the channel-to-channel skew and adequate intercard signal quality, the shortest intercard connecting cable should be used and the expansion cards should be no more than two slots away from the master card. See figure 2-11.

PROCEDURE:

- a. Turn instrument power switch off, unplug power cord and disconnect any input or output connections.
- b. Starting **from the top**, loosen thumb screws on filler panel(s) and card(s).
- c. Starting **from the top**, begin pulling card(s) and filler panel(s) out **half way**. See figure 2-10.

CAUTION

All multi-card modules will be cabled together. Care should be taken to pull these cards out together.

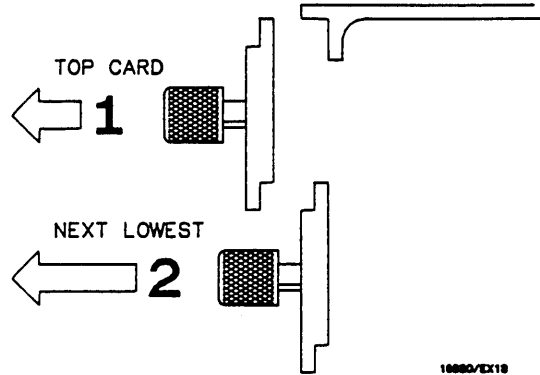

Figure 2-10. Endplate Overlap

- d. Pull all cards in pattern generator module completely out.
- e. Disconnect intercard connecting cable from all cards.
- f. Use figure 2-11 and figures 2-3 through 2-6 to plan the new configuration and to select the proper intercard connecting cable.

MASTER AND EXPANSION CARD ORIENTATION

ANY SLOT	ANY TWO ADJACENT SLOTS	ANY THREE ADJACENT SLOTS	ANY FOUR ADJACENT SLOTS	ALL SLOTS

SLOT SELECTION

16520/EX07

Figure 2-11. Configuration Guide

- g. Go to step "e" of the procedure "MODULE INSTALLATION" in paragraph 2-8 and continue from that point.

2-10. OPERATING ENVIRONMENT

The operating environment is listed in table 1-2. Note the non-condensing humidity limitation. Condensation within the instrument can cause poor operation or malfunction. Protection should be provided against internal condensation.

The HP 16520/21A will operate at all specifications within the temperature and humidity range given in table 1-2. However, reliability is enhanced by operating the instrument within the following ranges.

Temperature: +20 to +35°C (+68 to +95°F)
Humidity: 20% to 80% non-condensing

2-11. STORAGE

The module may be stored or shipped in environments within the following limits:

Temperature: -40°C to +75°C
Humidity: Up to 90% at 65°C
Altitude: Up to 15,300 meters (50,000 Feet)

The module should also be protected from temperature extremes, which cause condensation on the module.

2-12. PACKAGING

Follow these general instructions for repacking the module with commercially available materials.

- Wrap module in anti-static plastic.
- Use a strong shipping container. A double-wall carton made of 350 lb. test material is adequate.
- Use a layer of shock-absorbing material 70-to-100 mm (3-to- 4 inch) thick around all sides of the module to provide firm cushioning and prevent movement inside the container.
- Seal shipping container securely.
- Mark shipping container FRAGILE to ensure careful handling.
- In any correspondence, refer to module by model number and board number.

2-13. TAGGING FOR SERVICE

If the module is to be shipped to a Hewlett-Packard office for service or repair, attach a tag with your name and address, the complete board number, and a description of the service required.

TABLE OF CONTENTS

PERFORMANCE TESTS

3-1. Introduction	3-1
3-2. Recommended Test Equipment	3-1
3-3. Test Record	3-1
3-4. Performance Test Interval	3-1
3-5. Performance Test Procedures	3-1
3-6. Data Period Accuracy Test	3-2
3-7. Duty Cycle Test	3-8

SECTION III

PERFORMANCE TESTS

3-1. INTRODUCTION

The procedures in this section test the pattern generator's electrical performance using the specifications listed in Section I as the performance standards. All tests can be performed without access to the interior of the instrument. At the end of this section is a form that can be used as a record of performance test results.

3-2. RECOMMENDED TEST EQUIPMENT

Equipment recommended for performance tests is listed in table 1-3. Any equipment that satisfies the critical specifications given in the table may be substituted for the recommended models.

3-3. TEST RECORD

Results of performance tests may be tabulated in the Performance Test Record (table 3-1) at the end of the procedures. The test record lists

all of the tested specifications and their acceptable limits. The results recorded in the test record may be used for comparison in periodic maintenance and troubleshooting or after repairs and adjustments have been made.

3-4. PERFORMANCE TEST INTERVAL

Periodic performance verification of the HP 16520/21A Pattern Generator Module is required at two year intervals. The instrument's performance should be verified after it has been serviced, or if improper operation is suspected. Calibration should be performed before any performance verification tests. Further checks requiring access to the interior of the instrument are included in the adjustment section, but are not required for the performance verification.

3-5. PERFORMANCE TEST PROCEDURES

All performance tests should be performed at the instrument's environmental operating temperature and after a 15-minute warm up.

3-6. Data Period Accuracy Test

SPECIFICATION: $\pm 2\%$ (of period) $\pm 1\text{ns}$

EQUIPMENT:

Oscilloscope	HP 54201A
BNC Cable	HP 10502A
BNC Adapter	HP 1250-1032
Probe Lead Set	HP 10347A
Grabber (2)	HP 5959-0288

DESCRIPTION:

The purpose of this test is to verify the data period accuracy of the internal clock at its slowest and fastest clock ranges. (For best results, terminate into 10 k Ω , 10 pF)

PROCEDURE:

- a. Connect data output channel 0 and the corresponding ground from a selected output data cable, to the oscilloscope as shown in figure 3-1. The output cables can be internally connected for either TTL or ECL.

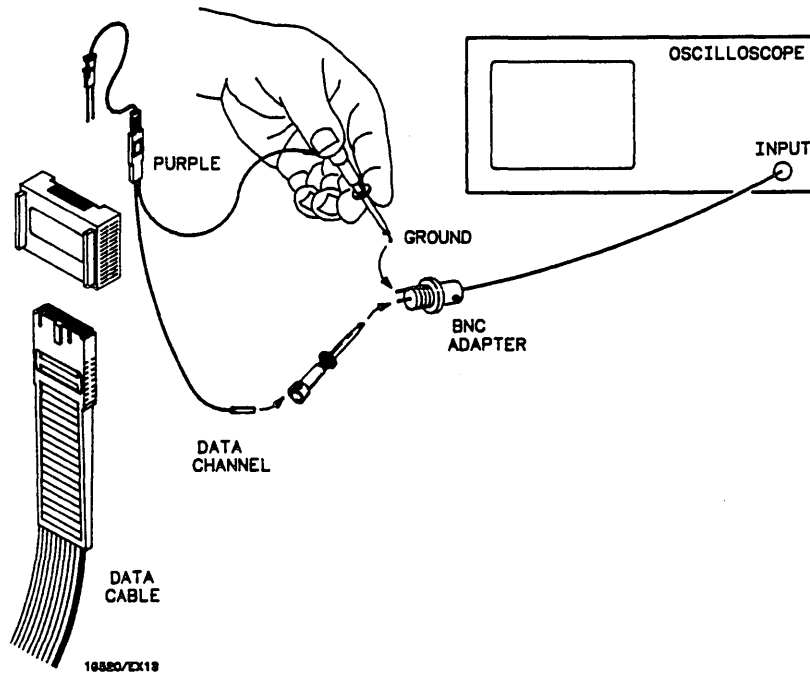

Figure 3-1. Data Period Accuracy Test Equipment Hookup

- b. Apply power to the HP 16500A and wait for system bootup.

c. From the startup screen shown in figure 3-2, touch the following fields in the sequence below:

1. **System**
2. **Pattern Gen** (If multiple HP 16520A Cards, pick one to be tested)

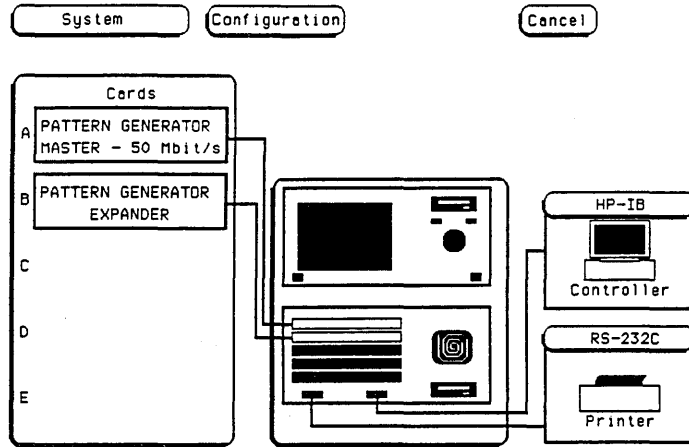

Figure 3-2. Startup Screen

d. In the Format screen, touch **Clock** field and set to Internal as shown in figure 3-3.

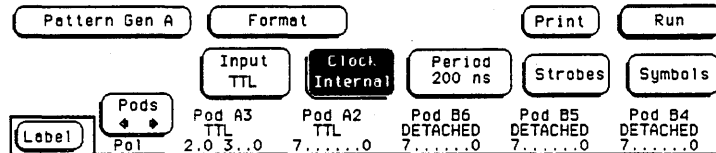

Figure 3-3. Clock Field

- e. Touch **Period** and set Internal clock to 200 μ s as shown in figure 3-4.

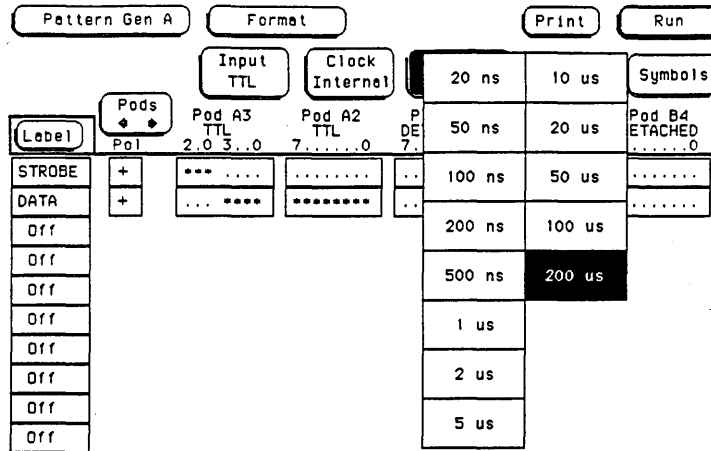

Figure 3-4. Clock Period Screen

- f. Touch channel assignment field for the selected input cable. See figure 3-5.

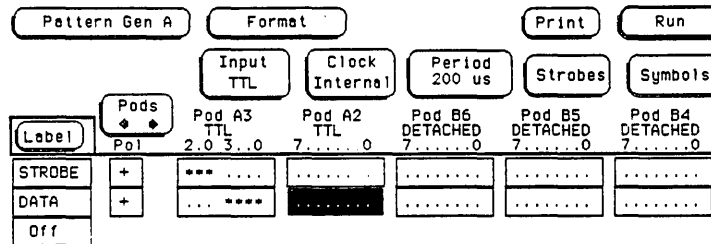

Figure 3-5. Channel Assignment Field

- g. Select data output channel 0 as shown in figure 3-6. Touch **Done**.

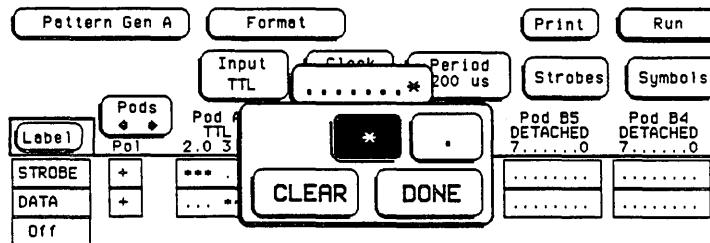

Figure 3-6. Data Channel Select

- h. Touch **Format**, then touch **Listing**.

i. From the listing screen, program the pattern generator as follows:

1. Touch program field as shown in figure 3-7.

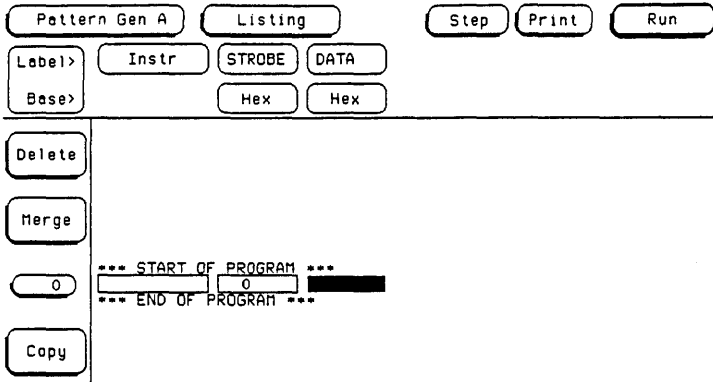

Figure 3-7. Program Field

2. Touch 1 as shown in figure 3-8, then touch Done.

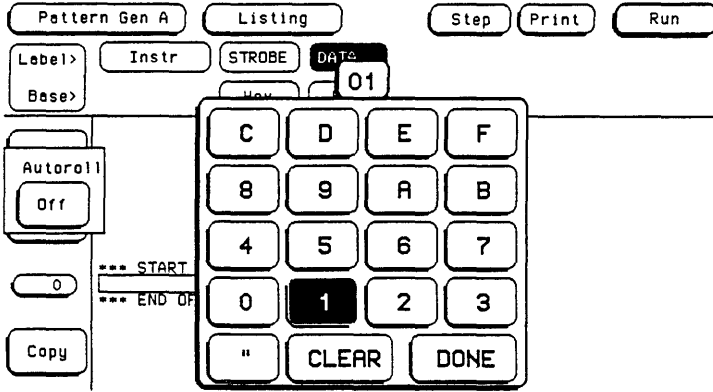

Figure 3-8. Numeric Entry

3. Touch Insert as shown in figure 3-9.

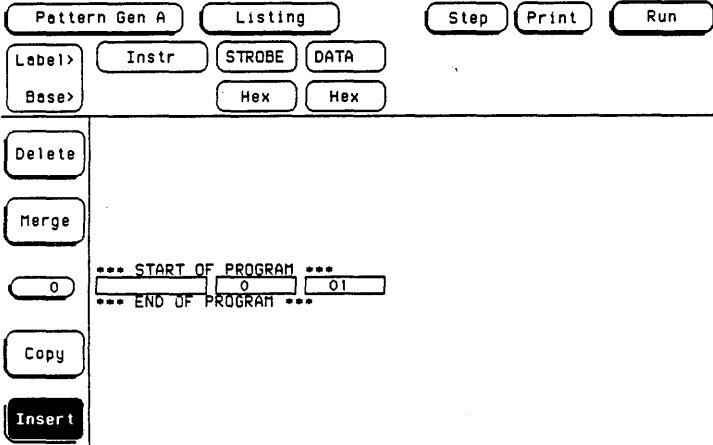

Figure 3-9. Insert New Program Line

4. Touch program field as shown in figure 3-10.

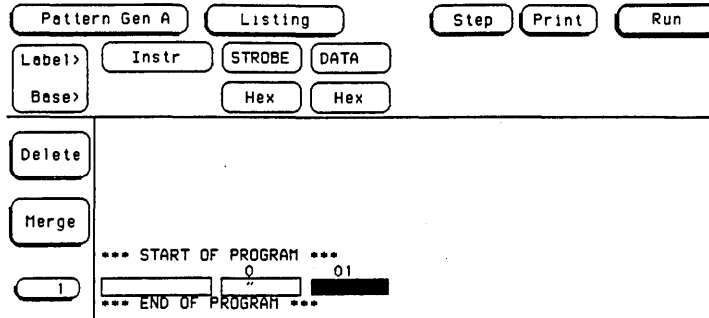

Figure 3-10. Program Field

5. Enter 0s as shown in figure 3-11, then touch Done.

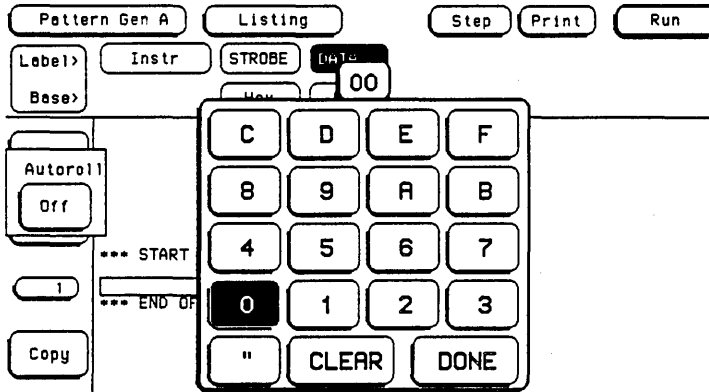

Figure 3-11. Numeric Entry

6. Repeat steps 1 through 5 until there is a short program starting with a one (1) and ending with a zero (0). See figure 3-12.

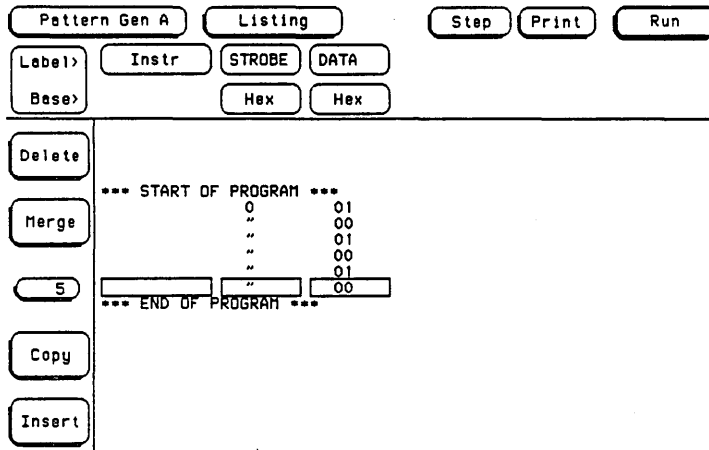

Figure 3-12. Example Program

- j. Touch **Run**, then drag finger to **Repetitive** as shown in figure 3-13.

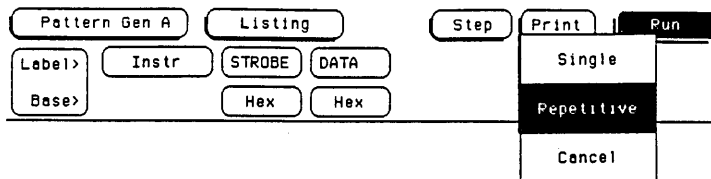

Figure 3-13. Run Repetitive Mode

- k. Using the oscilloscope, measure pulse period at 50% point on waveform.
- l. The pulse high time and low time should each measure between 196 μ s and 204 μ s.
- m. Touch **Stop**.
- n. Touch **Listing**, then touch **Format**.
- o. Touch **Period**.
- p. Change period to 20 ns.
- q. Touch **Run**, then drag finger to **Repetitive**.
- r. Using the oscilloscope, measure pulse period at 50% point on waveform.
- s. Pulse high time and low time should each measure between 18.6 ns and 21.4 ns.
- t. Touch **Stop**.

Note

This test arbitrarily selects data channel 0 on one of the data output cables. If desired, other output channels and cables may be substituted or added to this procedure.

3-7. Duty Cycle Test

SPECIFICATION: 10 ns minimum high time; 10 ns minimum low time

EQUIPMENT:

Oscilloscope	HP 54201A
Pulse Generator	HP 8116A
BNC Cable (2)	HP 10502A
BNC Adapter (2)	HP 1250-1032
50 Ohm Feedthru	HP 10100C
Probe Lead Set	HP 10347A
Grabbers (4)	HP 5959-0288

DESCRIPTION:

The purpose of this test is to verify that the internal clock circuits will respond to the minimum high and low times of the user supplied clock. (For best results, terminate into 10 k Ω , 10 pF)

PROCEDURE:

- a. Connect test equipment as shown in figure 3-14.

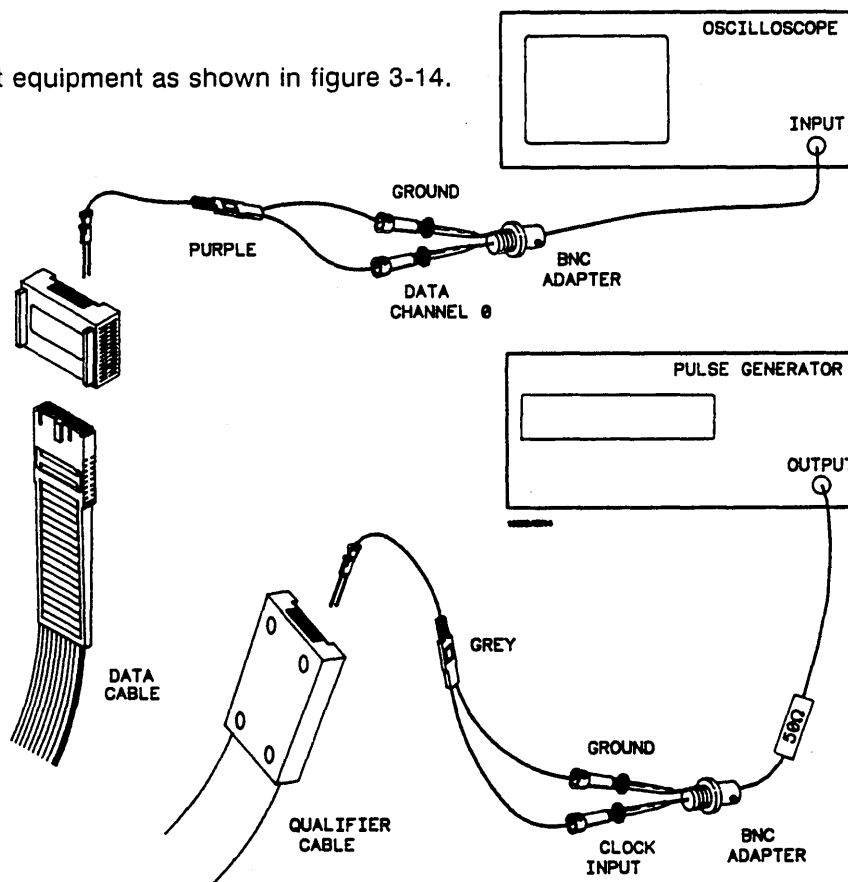

Figure 3-14. Duty Cycle Test Equipment Hookup

- b. Apply power to the 16500A and wait for system bootup.
- c. Set pulse generator for a 50 MHz square wave, 50% duty cycle, and an amplitude of 5 Volts.

d. From the startup screen shown in figure 3-15, touch the following field in the ordered sequence below:

1. System
2. Pattern Gen (If multiple HP 16520A Cards, pick one to be tested)

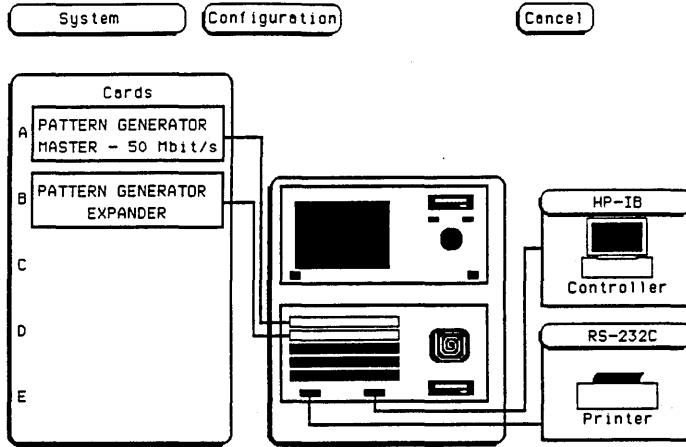

Figure 3-15. Startup Screen

e. Touch Input field to set input level to TTL as shown in figure 3-16.

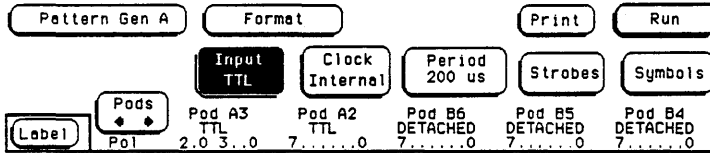

Figure 3-16. Set TTL Level

f. Touch Clock field and set to External as shown in figure 3-17.

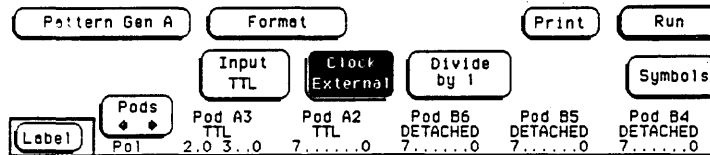

Figure 3-17. Clock Field

- g. Touch **Divide** field and set to **By 1**. See figure 3-18.

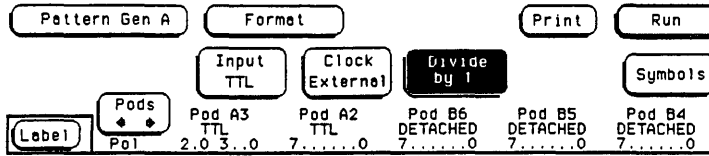

Figure 3-18. Divide By 1 Field

- h. Touch channel assignment field for the selected output pod. See figure 3-19.

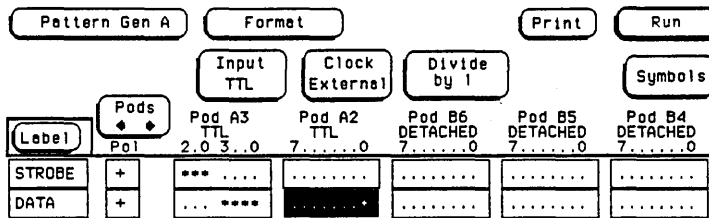

Figure 3-19. Channel Assignment Field

- i. Select data output 0 as shown in figure 3-20. Touch **Done**.

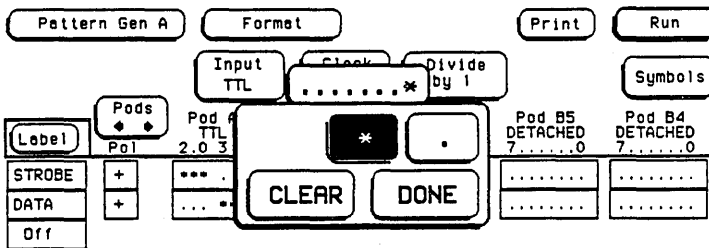

Figure 3-20. Data Output Select

- j. Touch **Format**, then touch **Listing**.

- k. Perform step i in paragraph 3-6, "DATA PERIOD ACCURACY TEST" for a program as shown in figure 3-21.

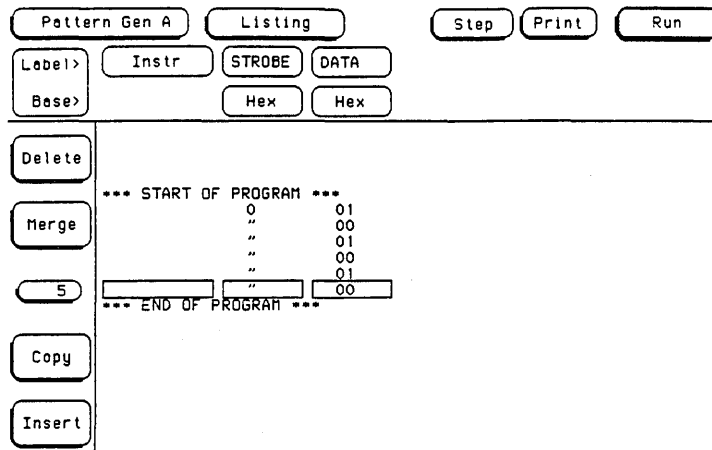

Figure 3-21. Example Program

- l. Touch **Run**, then drag finger to **Repetitive** as shown in figure 3-22.

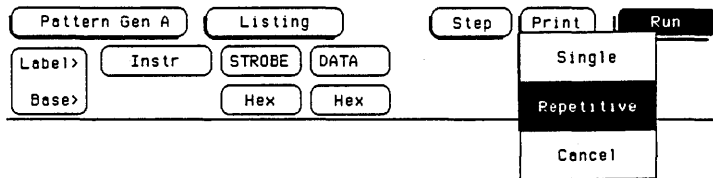

Figure 3-22. Run Repetitive Mode

- m. Set oscilloscope timebase to display a pulse stream.
- n. Look for a 25 MHz square wave pulse stream with approximately 20 ns low times and 20 ns high times. See figure 3-23. The presence of a consistent pulse stream verifies the external clock circuits are working.

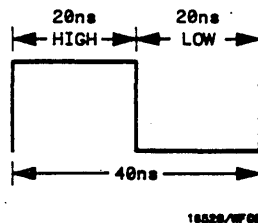

Figure 3-23. 25 MHz Square Wave

- o. Touch **Stop**.

Table 3-1. Performance Test Record

Hewlett-Packard Model 16520/21A Pattern Generator Card		Tested by _____ Work Order No. _____ Date Tested _____
Board No. _____		
Recommended Calibration Interval <u>24</u> Months		
Paragraph No	Test	Results
3-5	Data Period Accuracy @ 200 us	Minimum = 196 us Maximum = 204 us Actual _____
	Data Period Accuracy @ 20 ns	Minimum = 18.6 ns Maximum = 21.4 ns Actual _____
3-6	Duty Cycle	Is pulse stream visible ? Yes _____ No _____

TABLE OF CONTENTS

ADJUSTMENTS

4-1. Introduction	4-1
4-2. Calibration Interval	4-1
4-3. Safety Requirements	4-1
4-4. Recommended Test Equipment	4-1
4-5. Extender Board Installation	4-1
4-6. Instrument Warmup	4-4
4-7. Adjustment And Calibration Check	4-4

SECTION IV ADJUSTMENTS

4-1. INTRODUCTION

This section provides information on when to calibrate the module and how to calibrate, adjust and warm up the module. Also included in this section are equipment setups, a list of recommended test equipment and a procedure for installation of the extender board.

4-2. CALIBRATION INTERVAL

To maintain proper operation of the HP 16520/21A Pattern Generator Module, calibration should be performed at approximately two year intervals when the instrument is being used under normal operating conditions. If the instrument is used more than one shift per day, it may have to be calibrated more often.

New modules are preadjusted at the factory to meet the specifications listed in Section 1 of this manual. Before any adjustments are made to the module, the performance tests in Section III should be done. If the performance tests are within specifications, then adjustments are not necessary. If adjustments are necessary, refer to the safety summary at the front of this manual.

4-3. SAFETY REQUIREMENTS

Specific warnings, cautions, and instructions are placed wherever applicable throughout the manual. These must be observed during all phases of operation, service, and repair of the module. Failure to comply with them violates safety standards of design, manufacture, and intended use of this module. Hewlett-Packard assumes no liability for the failure of the customer to comply with these safety requirements.

4-4. RECOMMENDED TEST EQUIPMENT

Recommended adjustment test equipment is listed in table 1-3. Any equipment that satisfies the critical specifications given in the table may be substituted for the recommended models.

4-5. EXTENDER BOARD INSTALLATION

Before any adjustments or calibration checks are done, the HP 16520A Card must be installed on an extender board. The procedure for this installation is on the next page.

Extender Board Installation (cont.)

CAUTION

The effects of ELECTROSTATIC DISCHARGE can damage electronic components. Use grounded wriststraps and mats when performing any kind of service to this instrument or the cards in it.

INSTALLATION CONSIDERATIONS:

- The extender board may be installed in any available slot in the card cage.
- Cards below the slot used by the extender board do not have to be removed.
- The probe cables do not have to be removed to adjust the HP 16520A Card.

PROCEDURE:

- a. Turn instrument power switch off, unplug power cord and disconnect any input or output connections.
- b. Starting from the top, loosen thumb screws on filler panel(s) and card(s).
- c. Starting from the top, begin pulling card(s) and filler panel(s) out half way. See figure 2-1.

CAUTION

All multi-card modules will be cabled together. Care should be taken to pull these cards out together.

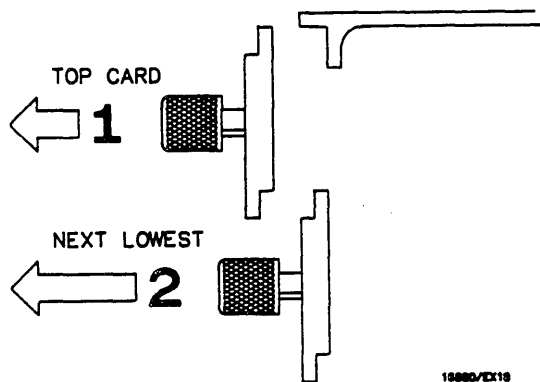

Figure 4-1. Card Endplate Overlap

- d. Pull module (one or more cards) to be serviced completely out and disconnect intercard connecting cable from the card(s).

- e. Push all other cards part way into the card cage, but **not completely** in so they won't be in your way when you install the extender board.
- f. Slide extender board completely into card cage making sure it is firmly seated in backplane connector.
- g. Plug HP 16520A Card into extender board. See figure 4-2.

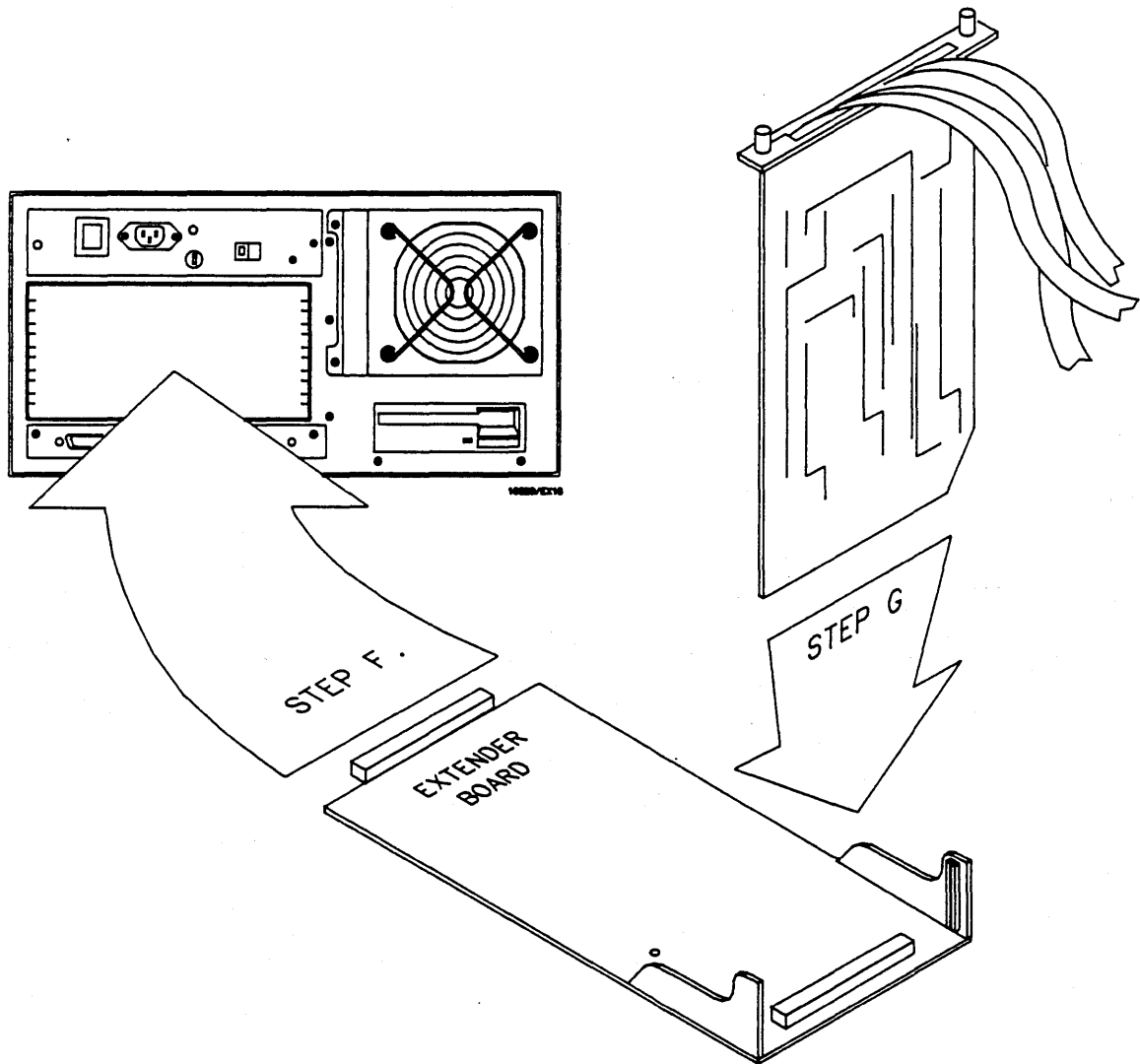

Figure 4-2. Extender Board and Module

4-6. INSTRUMENT WARMUP

Always adjust and check the calibration of the instrument at its environmental ambient temperature and after a 15 minute warm-up.

4-7. ADJUSTMENT AND CALIBRATION CHECK

There is one calibration check on the HP 16520A card. If calibration is out, there will be one adjustment to make. This reference is preset at the factory and normally **should not need adjustment**. If, after referring to paragraph 3-4, "PERFORMANCE TEST INTERVAL", the reference voltage is suspected as a problem, perform the following procedure.

DESCRIPTION:

This procedure will check and adjust the +5 Volt reference for the D/A converter.

EQUIPMENT:

Multimeter HP 3468A

PROCEDURE:

- a. Connect the positive lead from the multimeter to TP1 and the negative lead to TP2. For the location of the test points and the adjustable resistor, refer to figure 4-3.

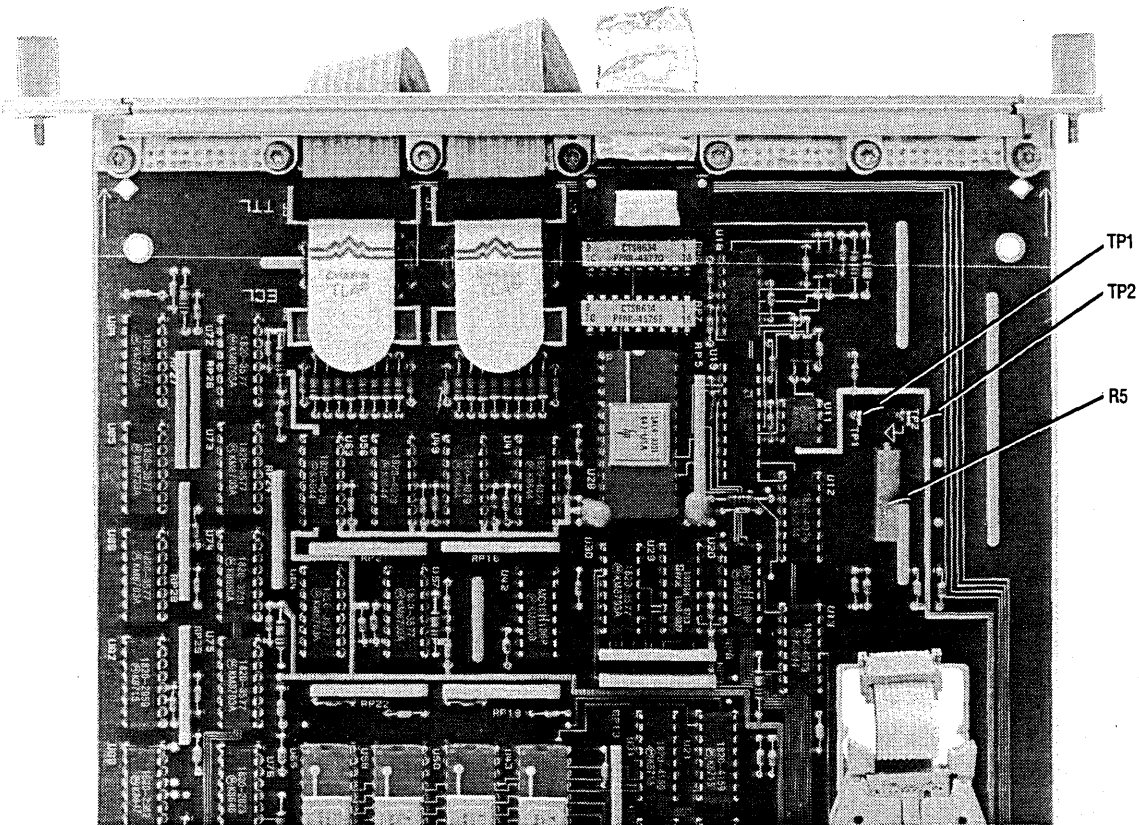

Figure 4-3. Adjustment Pot Location

- b. Set the multimeter to autorange and DC Volts.
- c. Plug power cord in, turn instrument power on, and wait for system bootup.
- d. From the startup screen shown in figure 4-4, touch the following fields in order:
 1. System
 2. Pattern Gen (If multiple HP 16520A cards, pick the one to be adjusted)
 3. Format
 4. Listing

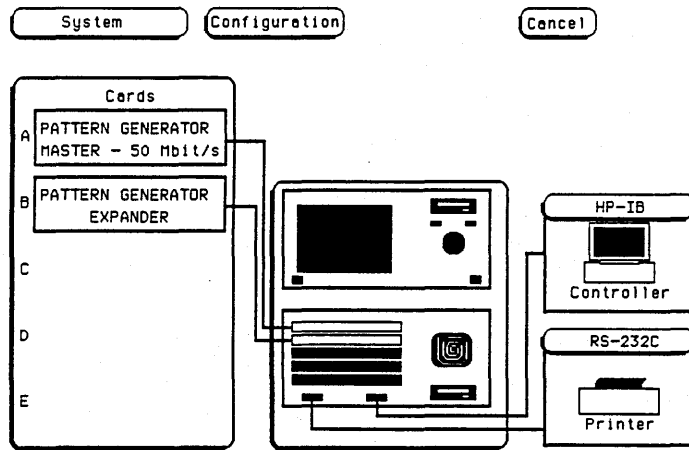

Figure 4-4. Startup Screen

- e. Touch Delete. See figure 4-5.

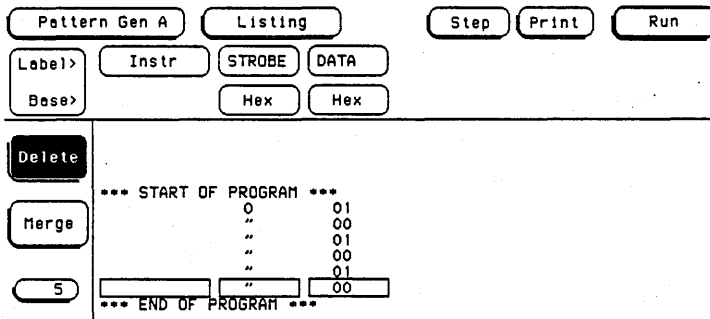

Figure 4-5. Delete Field

- f. Rotate knob counter clockwise until "START OF PROGRAM" comes down to midscreen and the program line field shows 0. See figure 4-6.

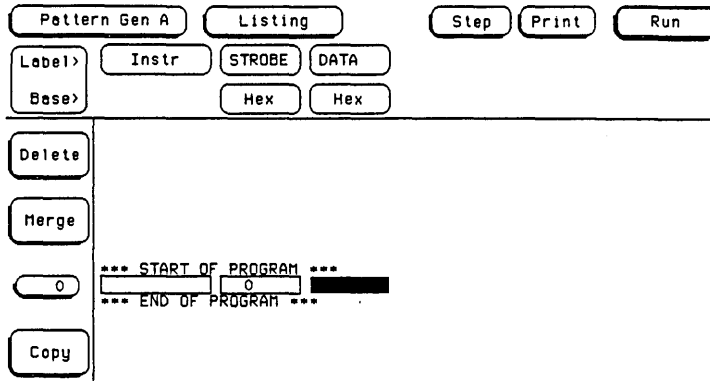

Figure 4-6. Program Line Field

- g. Touch Execute, Listing, then Format.
- h. Touch Input, then touch User Defined. See figure 4-7. Set level to +9.9 Volts, then touch Done.

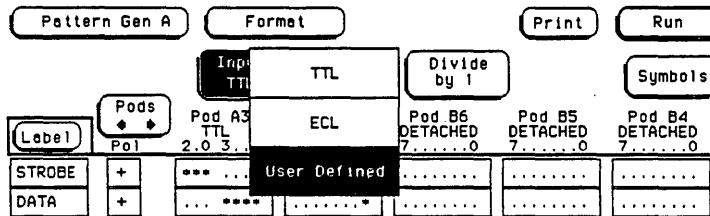

Figure 4-7. User Defined Field

- i. Touch Clock to set clock source to internal. See figure 4-8.

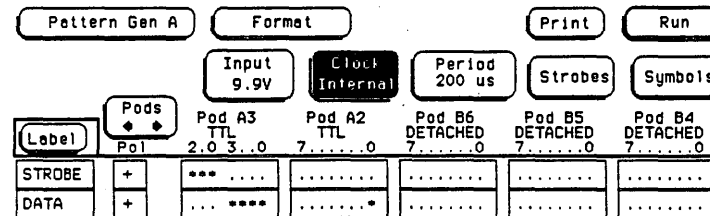

Figure 4-8. Internal Clock

- j. Touch **Period**, then **200 ns**. See figure 4-9.

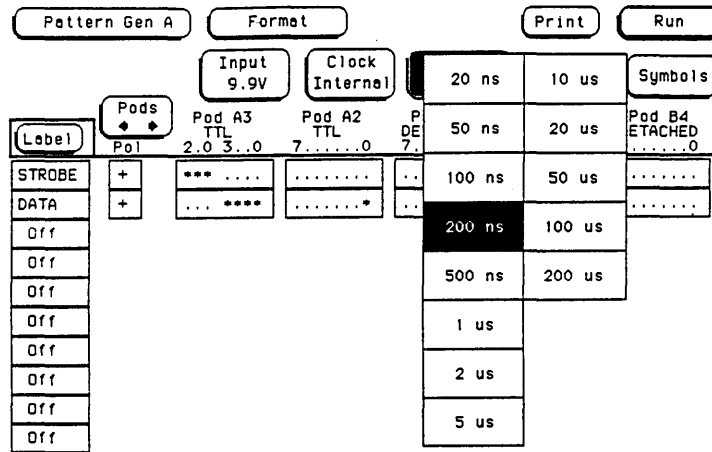

Figure 4-9. Period Selection

- k. Touch **Run**, then drag finger to **Single**. See figure 4-10.

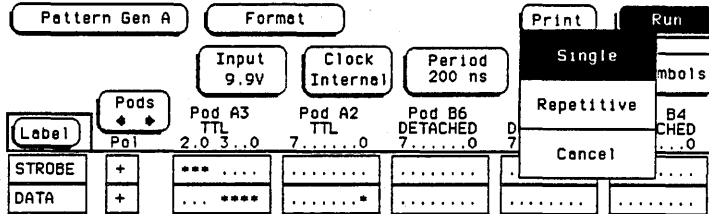

Figure 4-10. Run-Single Selection

Note

After you have started the pattern generator, the **Run** field will change to **Stop**, then very quickly change back to **Run**. This is the point the measurement is taken.

- i. Read the voltage displayed.
- m. With a non-metallic adjustment tool, adjust the variable resistor R5 until the multimeter reads 0.99 Volts (± 0.001 V).
- n. Set user defined level to -9.9 Volts and touch **Run**.

- o. Read the voltage displayed and note the difference between this reading and -0.99 Volts. Adjust R5 so this difference is halved (± 0.001 V).

Examples:

If reading is + 0.95 V, the difference is .04 V. Adjust R5 for + 0.97 V.

If reading is + 0.97 V, the difference is .02 V. Adjust R5 for + 0.98 V.

- p. Turn off instrument power, unplug power cable and disconnect all test equipment.
- q. Remove the HP 16520A Card from the extender board.
- r. At this point in the procedure, if you have multiple HP 16520A Cards to adjust, plug in the next HP 16520A card and repeat steps a through q.
- s. If you have completed the adjustment on the HP 16520A Card(s), remove extender board.
- t. To reinstall the pattern generator module, go to steps d through m of paragraph 2-8, "MODULE INSTALLATION".

TABLE OF CONTENTS

REPLACEABLE PARTS

5-1. Introduction	5-1
5-2. Abbreviations	5-1
5-3. Replaceable Parts List	5-1
5-4. Exchange Assemblies	5-1
5-5. Ordering Information	5-1
5-6. Direct Mail order System	5-2

SECTION V REPLACEABLE PARTS

5-1. INTRODUCTION

This section contains parts and ordering information for the HP 16520/21A Pattern Generator Module. Table 5-1 lists the reference designators and abbreviations used throughout this manual. Table 5-2 lists all replaceable parts by reference designator.

5-2. ABBREVIATIONS

Table 5-1 lists abbreviations used throughout the manual. In some cases two forms of the abbreviations are used, one in all capital letters, the other partially or not capitalized. We did this because the abbreviations in the parts list are always all capitals. However, in other parts of the manual other abbreviation forms are used with both lower and uppercase letters.

5-3. REPLACEABLE PARTS LIST

Table 5-2 lists replaceable parts and is organized as follows:

- a. Electrical assemblies in alphanumeric order by reference designation.
- b. Chassis-mounted parts in alphanumeric order by reference designation.
- c. Electrical assemblies and their components in alphanumeric order by reference designation.

The information given for each part consists of the following:

- a. Complete reference designation.
- b. Hewlett-Packard part number.
- c. Total quantity (Qty) of instrument.

- d. Description of part.
- e. Check digit.

The total quantity for each part is only given once at the first appearance of the part number in the list.

5-4. EXCHANGE ASSEMBLIES

Exchange assemblies are available when a repairable assembly is returned to Hewlett-Packard. These assemblies have been set up on the Blue-stripe Exchange program. This allows the customer to exchange the faulty assembly with one that has been repaired, calibrated, and performance verified by the factory. The cost is significantly less than that of a new assembly.

Exchange assemblies are listed in a separate section in the replaceable parts table. They have a part number in the form XXXXX-695XX (where the new parts would be XXXXX-665XX). Before ordering a blue-stripe assembly, check with your local parts or repair organization for procedures.

5-5. ORDERING INFORMATION

To order a part listed in the replaceable parts table, quote the Hewlett-Packard part number, check digit, indicate the quantity required, and address the order to the nearest Hewlett-Packard office.

To order a part that is not listed in the replaceable parts table, include the instrument model number, instrument serial number, the description and function of the part, and number of parts required. Address the order to the nearest Hewlett-Packard office.

5-6. DIRECT MAIL ORDER SYSTEM

Within the USA, Hewlett-Packard can supply parts through direct mail order. The advantages are as follows:

- a. Direct ordering and shipment from Hewlett Packard Parts Center in Mountain View, California.
- b. No maximum or minimum on any mail order (there is a minimum order for parts ordered through local Hewlett Packard offices when orders require billing and invoicing).

- c. Prepaid transportation (there is a small handling charge for each order).

- d. No invoices - to provide these advantages, check or money order must accompany each order.

Mail order forms and specific ordering information are available through your local Hewlett Packard offices.

Table 5-1. Reference Designators and Abbreviations.

REFERENCE DESIGNATORS			
A	=assembly	F	=fuse
B	=fan; motor	FL	=filter
BT	=battery	H	=hardware
C	=capacitor	J	=electrical connector (stationary portion); jack
CR	=diode; diode thyristor; varactor	L	=coil; inductor
DL	=delay line	MP	=misc. mechanical part
DS	=annunciator; lamp; LED	P	=electrical connector (moveable portion); plug
E	=misc. electrical part	Q	=transistor; SCR; triode thyristor
		R	=resistor
		RT	=thermistor
		S	=switch; jumper
		T	=transformer
		TB	=terminal board
		TP	=test point
		U	=integrated circuit; microcircuit
		V	=electron tube; glow lamp
		VR	=voltage regulator; breakdown diode
		W	=cable
		X	=socket
		Y	=crystal unit (piezo-electric or quartz)

ABBREVIATIONS			
A	=amperes	DWL	=dowel
A/D	=analog-to-digital	ECL	=emitter coupled logic
AC	=alternating current	ELAS	=elastomeric
ADJ	=adjust (ment)	EXT	=external
AL	=aluminum	F	=farads; metal film (resistor)
AMPL	=amplifier	FC	=carbon film/ composition
ANLG	=analog	FD	=feed
ANSI	=American National Standards Institute	FEM	=female
ASSY	=assembly	FF	=flip-flop
ASTIG	=astigmatism	FL	=flat
ASYNCHRO	=asynchronous	FM	=foam; from
ATTEN	=attenuator	FR	=front
AWG	=American wire gauge	FT	=gain bandwidth product
BAL	=balance	FW	=full wave
BCD	=binary-code decimal	FXD	=fixed
BD	=board	GEN	=generator
BFR	=buffer	GND	=ground(ed)
BIN	=binary	GP	=general purpose
BROG	=bridge	GRAT	=graticule
BSHG	=bushing	GRV	=groove
BW	=bandwidth	H	=henries; high
C	=ceramic; cermet (resistor)	HD	=hardware
CAL	=calibrate; calibration	HDND	=hardened
CC	=carbon composition	HG	=mercury
CCW	=counterclockwise	HGT	=height
CER	=ceramic	HLCL	=helical
CFM	=cubic feet/minute	HORIZ	=horizontal
CH	=choke	HP	=Hewlett-Packard
CHAM	=chamfered	HP-IB	=Hewlett-Packard Interface Bus
CHAN	=channel	HR	=hour(s)
CHAR	=character	HV	=high voltage
CM	=centimeter	HZ	=Hertz
CMOS	=complementary metal-oxide-semiconductor	I/O	=input/output
CMR	=common mode rejection	IC	=integrated circuit
CNDCT	=conductor	ID	=inside diameter
CNTR	=counter	IN	=inch
CON	=connector	INCL	=include(s)
CONT	=contact	INCAND	=incandescent
CRT	=cathode-ray tube	INP	=input
CW	=clockwise	INTEN	=intensity
D	=diameter	INTL	=internal
D/A	=digital-to-analog	INV	=inverter
DAC	=digital-to-analog converter	JFET	=junction field-effect transistor
DARL	=darlington	JKT	=jacket
DAT	=data	K	=kilo(10 ³)
DBL	=double	L	=low
DBM	=decibel referenced to 1mW	LB	=pound
DC	=direct current	LCH	=latch
DCDR	=decoder	LCL	=local
DEG	=degree	LED	=light-emitting diode
DEMUX	=demultiplexer	LG	=long
DET	=detector	LI	=lithium
DIA	=diameter	LK	=lock
DIP	=dual in-line package	LKWR	=lockwasher
DIV	=division	LS	=low power Schottky
DMA	=direct memory access	LV	=low voltage
DPDT	=double-pole, double-throw	M	=mega(10 ⁶); megohms; meter(distance)
DRC	=DAC refresh controller	MACH	=machine
DRVR	=driver	MAX	=maximum
		MFR	=manufacturer
		MICPROC	=microprocessor
		MINTR	=miniature
		MISC	=miscellaneous
		MLD	=molded
		MM	=millimeter
		MO	=metal oxide
		MTG	=mounting
		MTLC	=metallic
		MUX	=multiplexer
		MW	=milliwatt
		N	=nano(10 ⁻⁹)
		NC	=no connection
		NMOS	=n-channel metal-oxide-semiconductor
		NPN	=negative-positive-negative
		NPRN	=neoprene
		NRFR	=not recommended for field replacement
		NSR	=not separately replaceable
		NUM	=numeric
		OBD	=order by description
		OCTL	=octal
		OD	=outside diameter
		OP AMP	=operational amplifier
		OSC	=oscillator
		P	=plastic
		P/O	=part of
		PC	=printed circuit
		PCB	=printed circuit board
		PD	=power dissipation
		PF	=picofarads
		PI	=plug in
		PL	=plate(d)
		PLA	=programmable logic array
		PLST	=plastic
		PNP	=positive-negative-positive
		POLYE	=polyester
		POS	=positive; position
		POT	=potentiometer
		POZI	=pozidrive
		PP	=peak-to-peak
		PPM	=parts per million
		PRCN	=precision
		PREAMP	=preamplifier
		PRGMBL	=programmable
		PRL	=parallel
		PROG	=programmable
		PSTN	=position
		PT	=point
		PW	=potted wirewound
		PWR	=power
		R-S	=reset-set
		RAM	=random-access memory
		RECT	=rectifier
		RET	=retainer
		RF	=radio frequency
		RGLTR	=regulator
		RGTR	=register
		RK	=rack
		RMS	=root-mean-square
		RND	=round
		ROM	=read-only memory
		RPG	=rotary pulse generator
		RX	=receiver
		S	=Schottky-clamped; seconds(time)
		SCR	=screw; silicon controlled rectifier
		SEC	=second(time); secondary
		SEG	=segment
		SEL	=selector
		SGL	=single
		SHF	=shift
		SI	=silicon
		SIP	=single in-line package
		SKT	=skirt
		SL	=slide
		SLDR	=solder
		SLT	=slot(ted)
		SOLD	=solenoid
		SPCL	=special
		SQ	=square
		SREG	=shift register
		SRQ	=service request
		STAT	=static
		STD	=standard
		SYNCHRO	=synchronous
		TA	=tantalum
		TBAX	=tubeaxial
		TC	=temperature coefficient
		TD	=time delay
		THD	=thread(ed)
		THK	=thick
		THRU	=through
		TP	=test point
		TPG	=tapping
		TPL	=triple
		TRANS	=transformer
		TRIG	=trigger(ed)
		TRMR	=trimmer
		TRN	=turn(s)
		TTL	=transistor-transistor
		TX	=transmitter
		U	=micro(10 ⁻⁶)
		UL	=Underwriters Laboratory
		UNREG	=unregulated
		VA	=voltampere
		VAC	=volt, ac
		VAR	=variable
		VCO	=voltage-controlled oscillator
		VDC	=volt, dc
		VERT	=vertical
		VF	=voltage, filtered
		VS	=versus
		W	=watts
		W/O	=without
		WW	=wirewound
		XSTR	=transistor
		ZNR	=zener
		°C	=degree Celsius (Centigrade)
		°F	=degree Fahrenheit
		°K	=degree Kelvin

Table 5-2. Replaceable Parts

Reference Designation	HP Part Number	CD	Qty.	Description	Mfr Code	Mfr Part Number
	16520-13501	1	1	HP 16520/21A OPER. SYS. DISC		
	16520-69502	9	1	HP 16520A EXCHANGE ASSY.		
	16521-69501	9	1	HP 16521A EXCHANGE ASSY.		
				HP 16520A		
	16520-61601	1	1	INPUT QUALIFIER PROBE CABLE		
	16520-61602	3	1	8 CHANNEL DATA CABLE		
	16520-61603	5	1	CLOCK PROBE CABLE		
	16520-69501	8	1	INPUT QUAL. PROBE KIT GREY		
	16515-40501	0	1	REAR PANEL STM		
	16515-40502	2	1	CLAMP-PANEL		
	16500-22401	5	2	PANEL SCREW		
	16520-62102	1	1	LEAD SET PURPLE 10347A		
	0515-0430	3	3	MSPH M3 6 SMS10		
	0515-0665	6	4	M3 X 14 PH T10		
	0510-0684	9	2	RETAINING RING		
	16500-29101	6	1	GROUND SPRING		
	16520-94305	1	1	PATT. GEN LABEL		
	16500-41201	3	3	RIBBON CABLE ID CLIP		
	5959-0291	9	1	SERIAL TAG		
				HP 16521A		
	16520-61602	3	6	8 CHANNEL DATA CABLE		
	16500-41201	3	6	RIBBON CABLE ID CLIP		
	16521-88701	1	1	INTERCARD CONNECT CABLE KIT		
	0515-0430	3	3	MSPH M3 6 SMS10		
	0515-0665	6	4	M3 X 14 PH T10		
	0510-0684	9	2	RETAINING RING		
	16500-29101	6	1	GROUND SPRING		
	16521-94308	2	1	PATT. GEN. EXP LABEL		
	16515-40501	0	1	REAR PANEL STM		
	16515-40502	2	1	CLAMP-PANEL		
	16500-22401	5	2	PANEL SCREW		
	5959-0291	9	1	SERIAL TAG		

TABLE OF CONTENTS

SERVICE

6-1. Introduction.....	6-1
6-2. Safety Requirements	6-1
6-3. Recommended Test Equipment	6-1
6-4. Module Block Diagram and Theory of Operation	6-1
6-5. Pattern Generator Theory of Operation	6-3
6-6. Expansion Card Theory of Operation	6-4
6-7. Self Tests	6-5
6-8. Troubleshooting	6-9
6-9. Card Replacement	6-32
6-10. Probe Cable Replacement	6-35

SECTION VI SERVICE

6-1. INTRODUCTION

This section contains information for servicing the HP 16520/21A Pattern Generator Module. Included is a block level theory of both cards and procedures for self diagnostics and troubleshooting. If a card or cable is determined faulty, procedures are provided for replacing the card or cable.

6-2. SAFETY REQUIREMENTS

Specific warnings, cautions, and instructions are placed wherever applicable throughout the manual. These must be observed during all phases of operation, service, and repair of the module. Failure to comply with them violates safety standards of design, manufacture, and intended use of this module. Hewlett-Packard assumes no liability for the failure of the customer to comply with these safety requirements.

6-3. RECOMMENDED TEST EQUIPMENT

Table 1-3 lists recommended test equipment. Any equipment that satisfies the critical

specification given in the table may be substituted for the recommended models.

6-4. MODULE BLOCK DIAGRAM AND THEORY OF OPERATION

The following paragraphs contain block level theory of operation. This theory is not intended for component level troubleshooting, rather it is to be used to help isolate a module failure to card level.

For component level troubleshooting, the HP 16520/21A Service Data Supplement is required. This supplement contains schematics, component level theory of operation, component locators and a parts list for the pattern generator module.

The HP 16520/21A Pattern Generator Module consists of one master card or one master card and one or more expansion cards. Up to four HP 16521A Expansion Cards can be connected to a single HP 16520A Pattern Generator Card for a total of 204 data output channels. See figure 6-1.

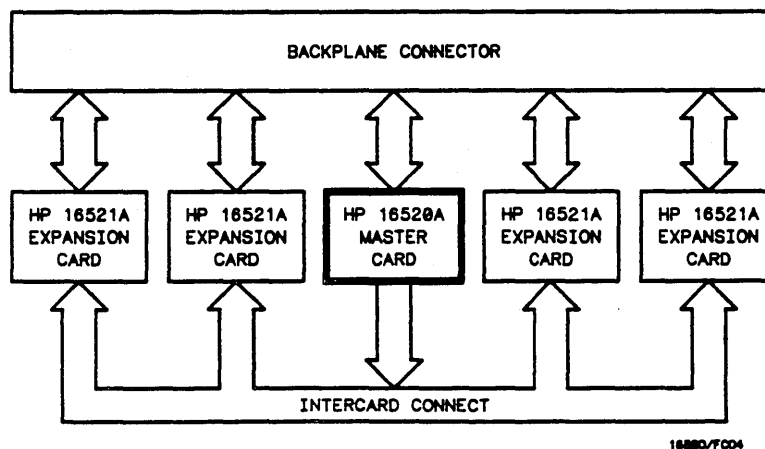

Figure 6-1. HP 16520/21A Pattern Generator Module Block Diagram

The HP 16520A Pattern Generator card is a stand alone digital stimulus card with 12 data output lines, 3 user defined strobes, and external inputs. The user stimulus program (up to 4k lines) is executed and controlled by the pattern generator master card.

The HP 16521A Pattern Generator Expansion Card is a 48 channel expander that extends the data channel width of the pattern generator master card. The pattern generator expansion card has only program data RAM (4k deep).

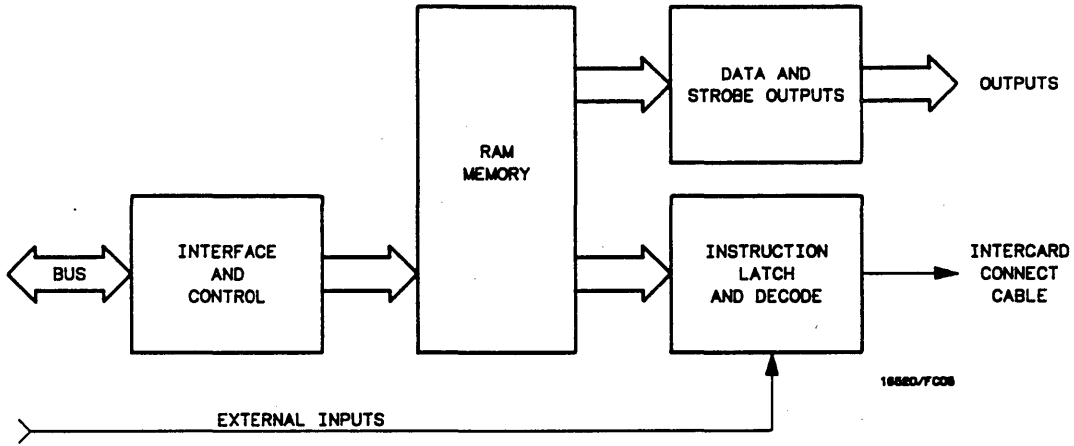

Figure 6-2. Pattern Generator Master Block Diagram

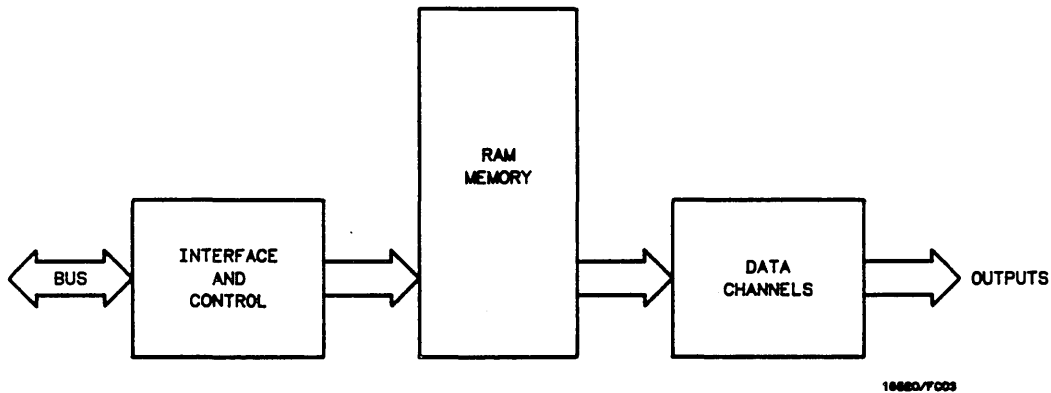

Figure 6-3. Pattern Generator Expansion Block Diagram

6-5. PATTERN GENERATOR THEORY OF OPERATION

Interface And Control

The microprocessor interface circuitry enables the pattern generator module to communicate via the mother board to other modules in the mainframe. User selectable pattern generator parameters and programs (stimulus output) are loaded into the pattern generator from the CPU. Pattern generator status is communicated to the CPU from the module.

The intermodule bus circuitry (IMB) enables the pattern generator module to trigger/arm other modules or be triggered/armed by the state of another module in the mainframe.

The clock circuitry is responsible for the generation of the user selectable clock rates. These user selectable clock rates come in three formats. The system master clock, minor clock, and the pre-master clock. The system master clock is fanned out to run the pattern generator and is the primary clock source in the pattern generator module. The minor clock is used to generate strobe channel timing and is typically a higher frequency than the system master. The pre-master clock is a slightly advanced version of the master clock and is used whenever setup time is necessary in the pattern generator module.

The program counter is 12-bits wide. With the 4k deep memory, 12-bits permits access to the complete address space. The counter can be parallel loaded and asynchronously reset.

Ram Memory

Three 4k x 4 RAMs are used to store the 12 data channel programs. Four 4k x 4 RAMs are used to store the three strobe channel parameters, the pattern generator instruction field and the instruction parameter field. This memory arrangement provides a 28-bit microword which controls the operation of the program counter and generates data and strobe vectors for the user.

Data And Strobe Outputs

The RAM data latch contains flip-flops that latch memory output data. After the memory data is latched, it sends ECL data out to be series terminated before becoming available to the user at a connector. The same ECL data, from the data latch, is translated to TTL and sent to be series terminated before becoming available to the user in the same manner. Output data voltage levels (TTL/ECL) are accessed by physically locating the data output cable in the appropriate connector.

There are three strobe channels that can be used to output user defined pulses. Within a single pattern generator program step, the strobe channel pulse can be controlled in increments of 1/10th or 1/5th of a program step. The user can define polarity, delay, and pulse width.

Instruction Latch And Decode

Just as the memory data is latched, the instruction data must also be latched. This circuit takes two of the five instruction opcode bits and decodes them. Three other opcode bits have dedicated hardware functions. The remaining eight instruction bits are for a parameter field. The parameter field bits are used by the REPEAT and WAIT EXT instructions.

The external input circuit enables the user to input three bits of external qualification information and an external clock. This external clock may be used in place of the internally generated clock. The external qualification information may stop the program counter with the WAIT EXT instruction until the input qualification conditions are met. Inputs can be TTL, ECL or user defined between +9.9 and -9.9 volts.

The repeat instruction counter is eight bits wide. The user may repeat a strobe/data pattern up to 256 times.

6-6. EXPANSION CARD THEORY OF OPERATION

Interface And Control

The interface and control circuitry enables the expansion card to receive pattern generation parameters and program data from the CPU and clock and control signals from the pattern generator master card.

The program counter is made of three 4-bit wide counters, making it 12-bits wide. With 4096 X 4 bit memory, 12-bits permits access to the complete address space. The counter can be parallel loaded and asynchronously reset. The expansion card program counter steps are based on the control signals from the master card.

RAM Memory

There are twelve 4096 X 4 bit, RAM chips on the 16521A card. Each RAM stores four channels of data, making the total number of outputs at 48.

Data Outputs

The RAM data latch contains flip-flops that latch memory output data. After the memory data is latched, it sends ECL data out to be series terminated before becoming available to the user at a connector. The same ECL data, from the data latch, is translated to TTL and sent to be series terminated before becoming available to the user in the same manner. Output data voltage levels (TTL/ECL) are accessed by physically locating the data output cable in the appropriate connector.

6-7. SELF TESTS

The self tests for the HP 16520/21A Pattern Generator Module will identify the improper operation of major functional areas in the module. They are not intended for component level diagnostics. If there are multiple pattern generator modules, they must be selected for testing at the main Test System menu.

All self tests can be run without access to the interior of the instrument. If a failure is found, the troubleshooting chart in paragraph 6-8 may require the installation of the extender board to isolate a specific card or cable.

CAUTION

The effects of ELECTROSTATIC DISCHARGE can damage electronic components. Grounded wriststraps and mats should be used when you perform any kind of service to this instrument or the cards in it.

SELF TEST ACCESS PROCEDURE:

- a. Disconnect all inputs and turn power switch on.
- b. From the startup screen shown in figure 6-4, touch **Configuration** field, then touch **Test**.

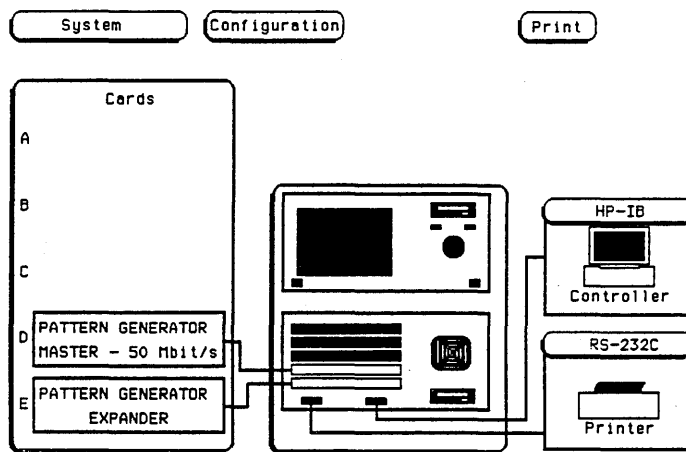

Figure 6-4. Startup Screen

c. Touch box to load Test System. See figure 6-5.

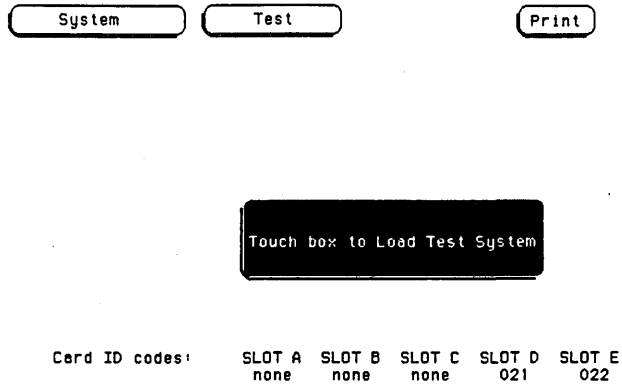

Figure 6-5. Load Test System

d. From test screen in figure 6-6, touch Test System, then touch Pattern Gen. (If multiple pattern generator modules, select the one to be tested)

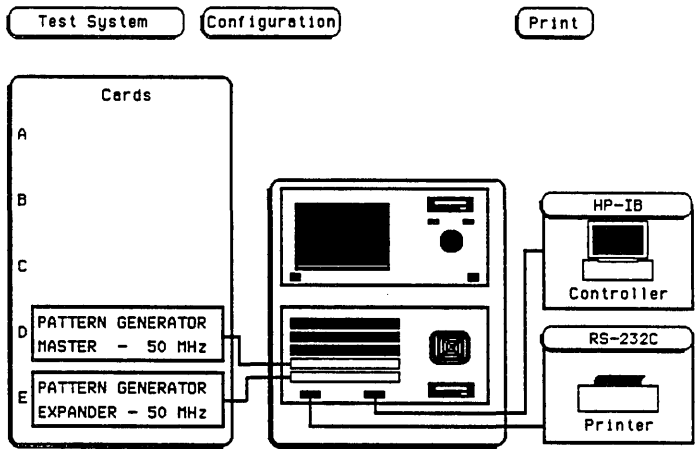

Figure 6-6. Test System Screen

- e. Figure 6-7 is the main self test menu. Self tests can be run individually by touching a specific test field, or all tests automatically one time by touching "All Pattern Gen Tests". When "All Pattern Gen Tests" is run, the test status will change to "TESTED". When individual tests are run, the status will change to either "PASSED or FAILED".

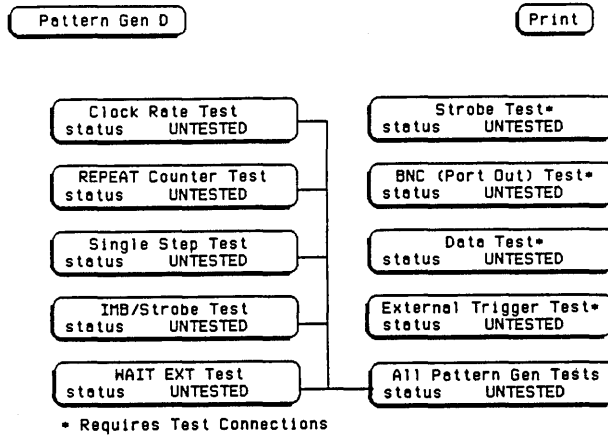

Figure 6-7. Main Test Menu

- f. Touch **Clock Rate Test**.
- g. An individual test run screen, see figure 6-8, will give the test name, a brief description of the test, number of test runs, and the number of test failures.

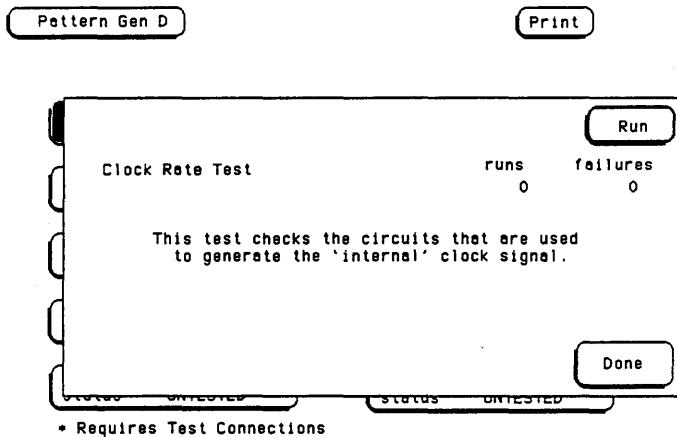

Figure 6-8. Clock Rate Test Run Screen

- h. Touch **Run**, then drag finger to **Single** or **Repetitive**.
- i. During the time a Single run or a Repetitive run is executing, the **Run** field will change to **Stop**.

- j. To stop a Repetitive run, touch **Stop**. See figure 6-9

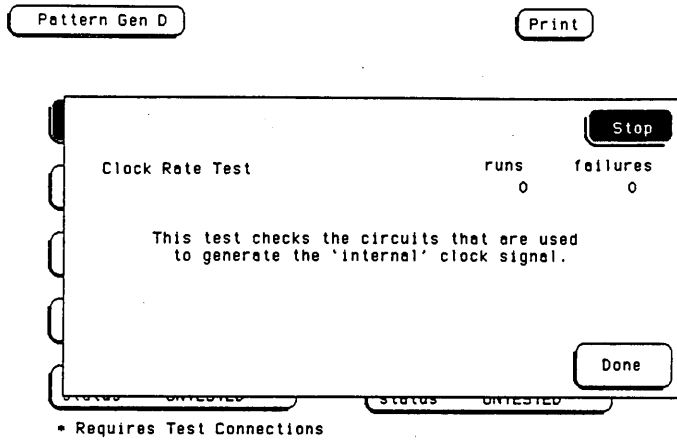

Figure 6-9. Stop Field

- k. To exit the self tests, touch the following fields in the numbered sequence below:

1. **Pattern Gen**
2. **Test System**
3. **Configuration**
4. **Exit Test**

- l. Touch the box to **Exit Test System**. See figure 6-10.

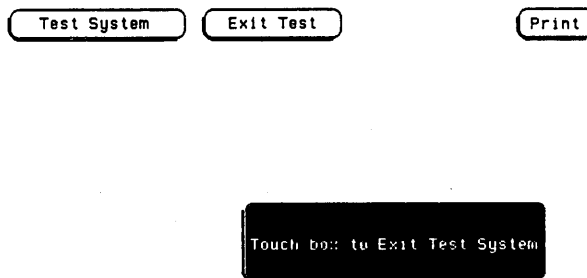

Figure 6-10. Exit Test System

TEST DESCRIPTIONS:**Clock Rate Test**

This test checks for clock occurrence and clock accuracy on the pattern generator master card.

Repeat Counter Test

This test checks the repeat counter on the pattern generator master card.

Single Step Test

This test verifies that a microprocessor "BREAK" instruction can be set and cleared by the pattern generator master card.

IMB/Strobe Test

This test checks the ability of the trigger circuits on the pattern generator master card to see and react to the IMB trigger/arm signals.

Wait External Test

This test checks the ability of the pattern generator master card to use the three external trigger lines.

Strobe Loopback Test

This test checks the strobe outputs of the pattern generator master card. An external connection is required.

BNC Loopback Test

This test verifies the ability of the pattern generator master card to both trigger and receive a signal from the BNC PORT IN and BNC PORT OUT on the microprocessor board.

Data Loopback Test

This test checks the data path of a single data pod for signal continuity and proper function of the buffers and other assorted circuitry. An external connection is required.

External Trigger Loopback Test

This test verifies the ability of the pattern generator master card to use the three external trigger lines during real data combination verification.

6-8. TROUBLESHOOTING

If self tests indicate a failure, begin at the **Start** of the troubleshooting flow chart shown in figure 6-11. When a specific test fails, you will be instructed to replace a faulty card or you will be referred to other flow charts for the isolation of the faulty card or cable.

Troubleshooting Sheet 1

TROUBLESHOOTING SHEET 1

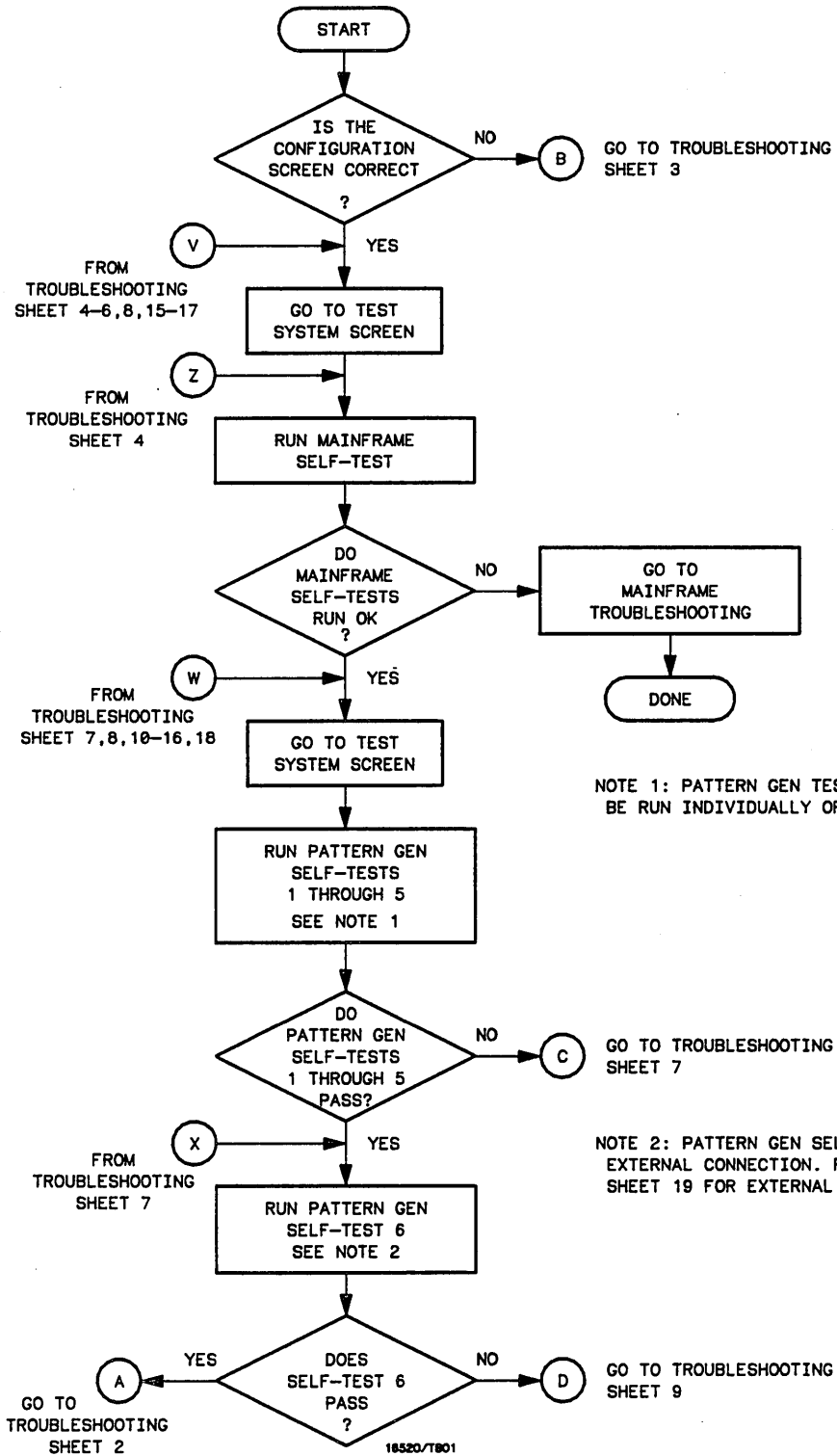
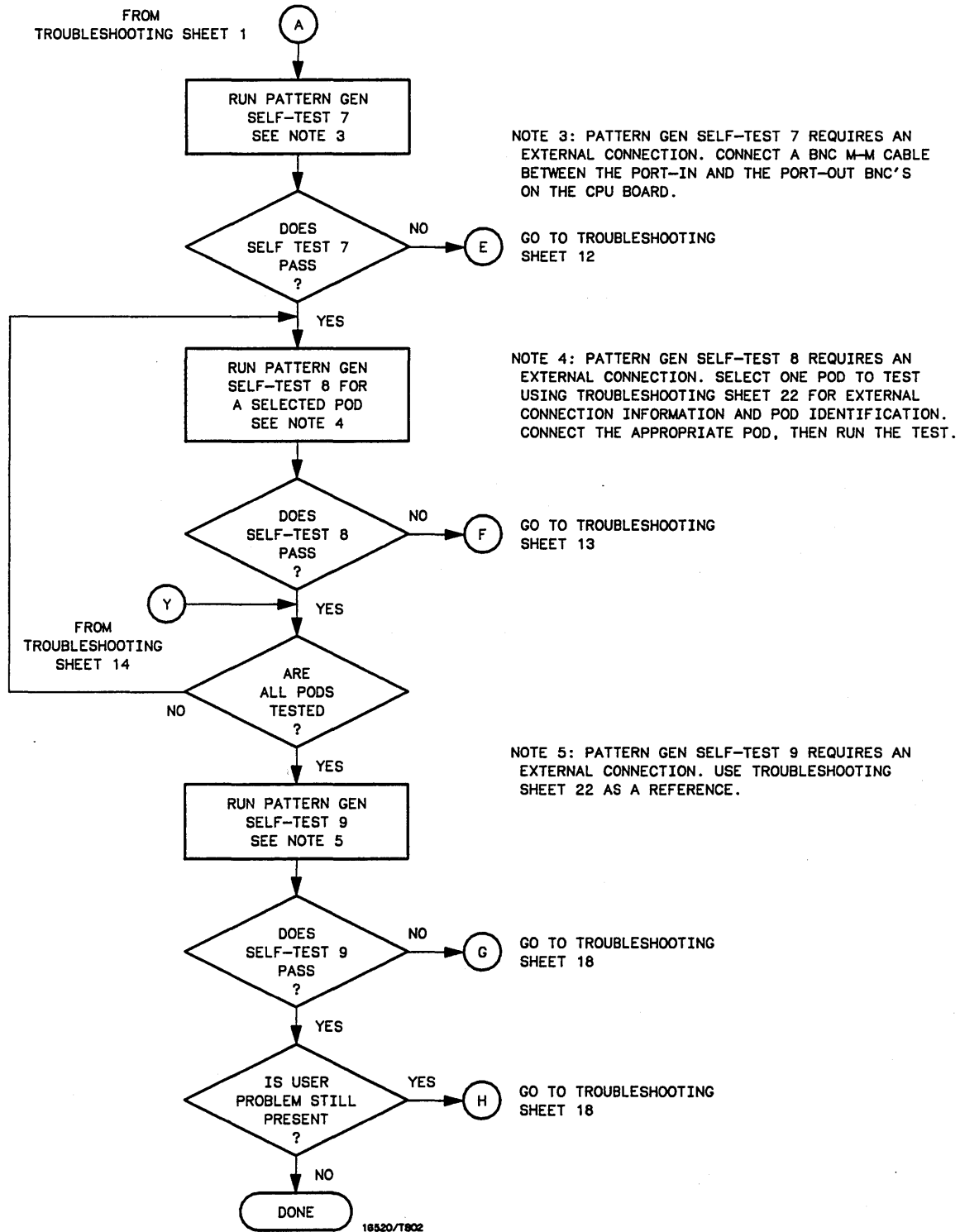

Figure 6-11. Troubleshooting Flow Chart

Troubleshooting Sheet 2



TROUBLESHOOTING SHEET 2

Figure 6-11. Troubleshooting Flow Chart (cont.)

Troubleshooting Sheet 3

TRoubleshooting Sheet 3

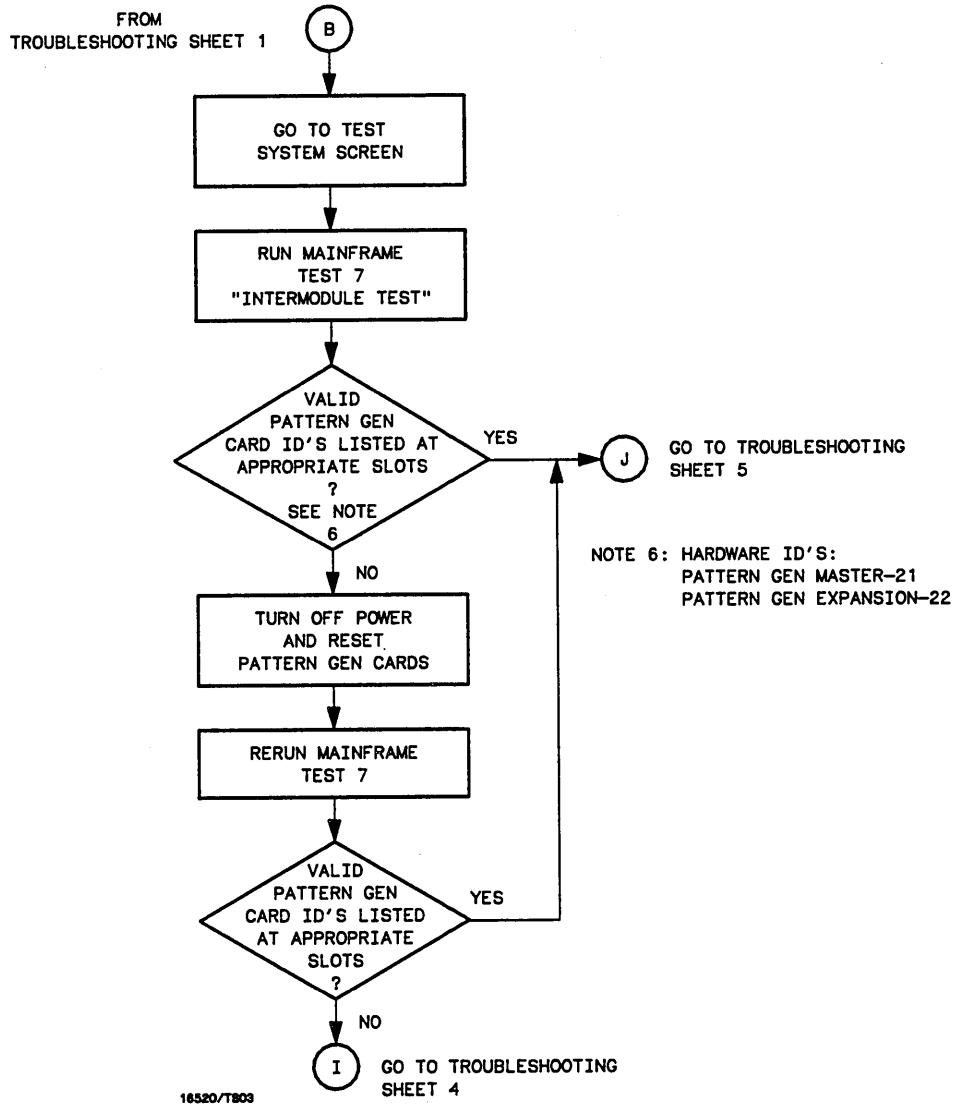
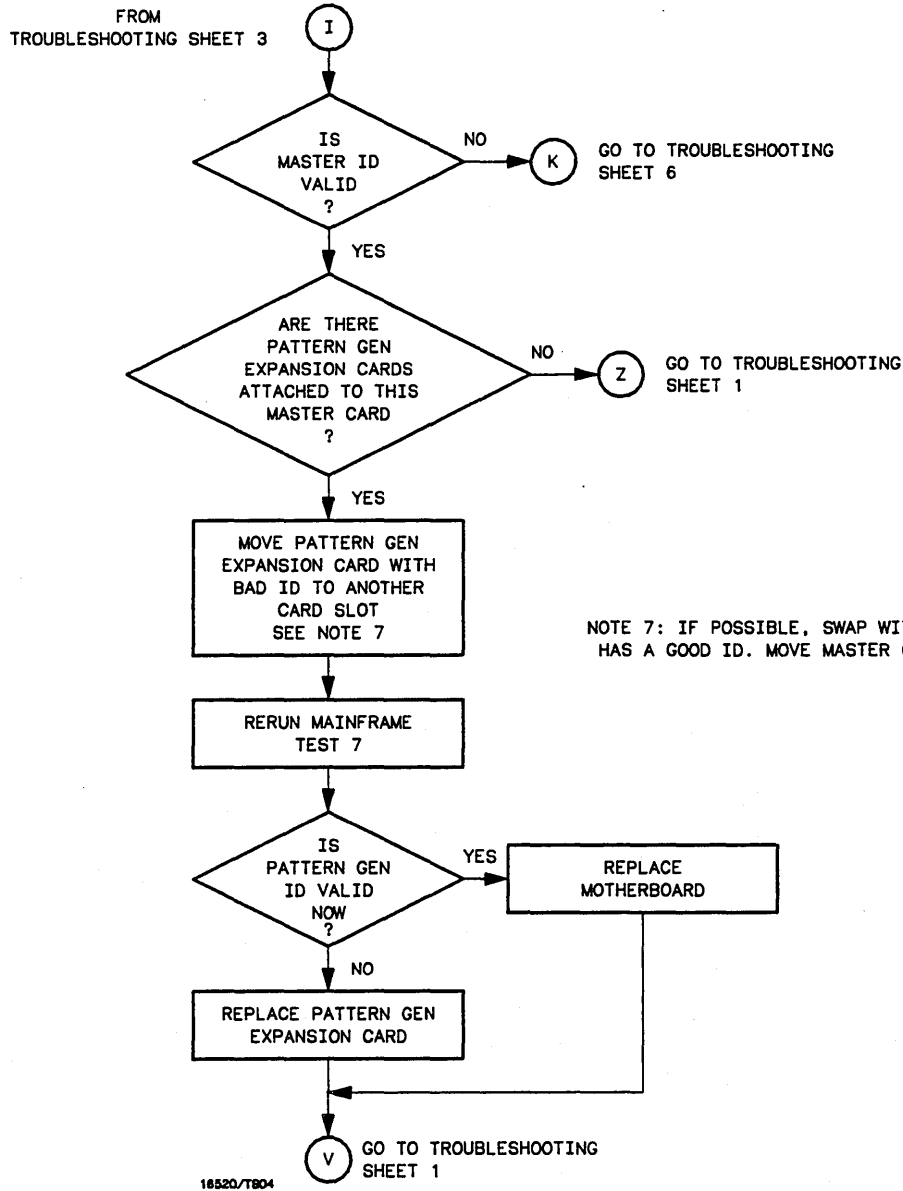

Figure 6-11. Troubleshooting Flow Chart (cont.)

Troubleshooting Sheet 4



TROUBLESHOOTING SHEET 4

Figure 6-11. Troubleshooting Flow Chart (cont.)

Troubleshooting Sheet 5

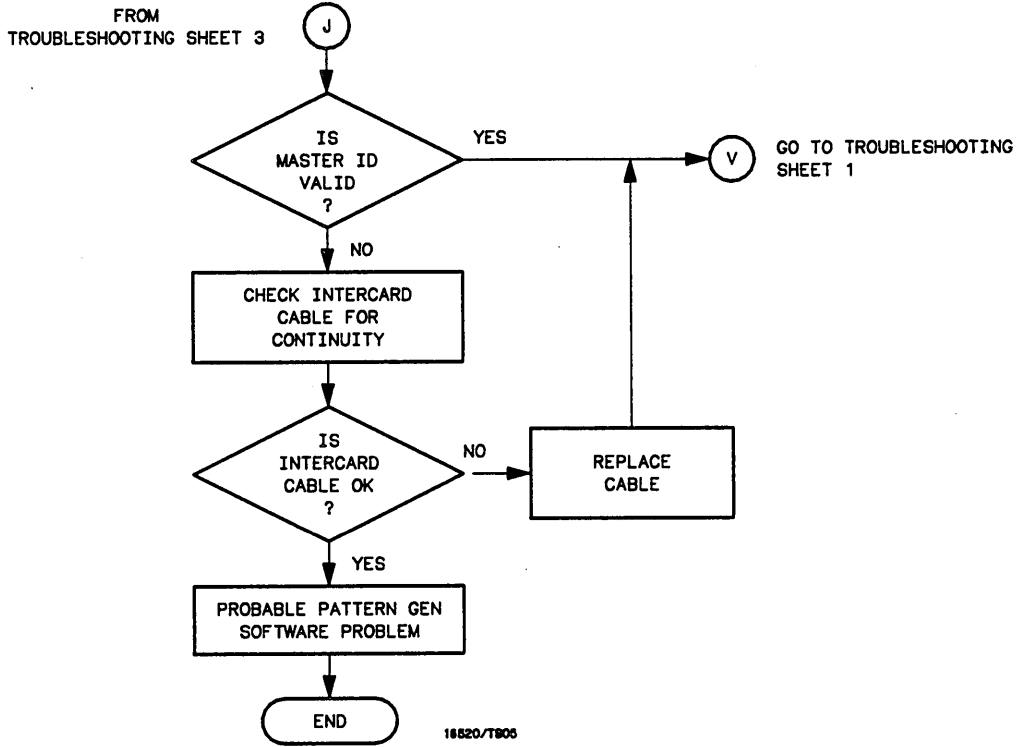

Figure 6-11. Troubleshooting Flow Chart (cont.)

TROUBLESHOOTING SHEET 5

Troubleshooting Sheet 6

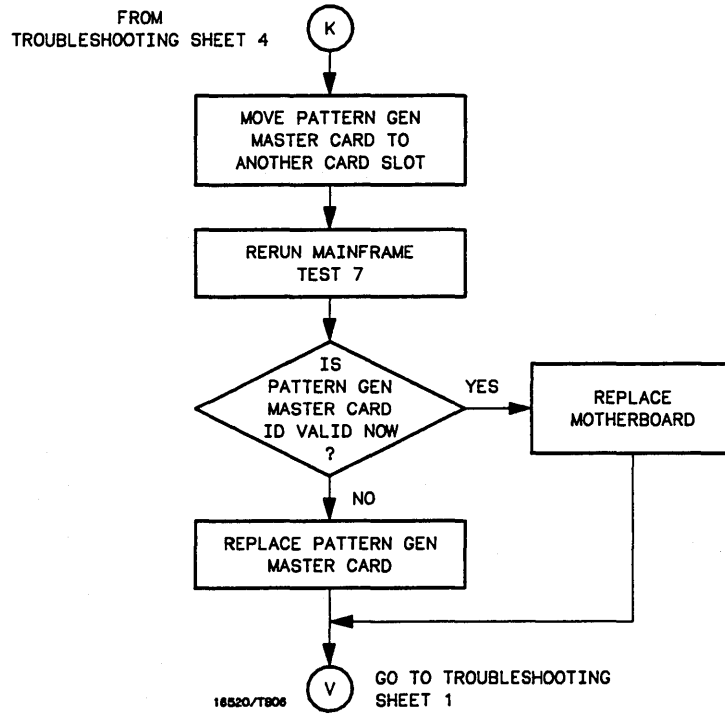
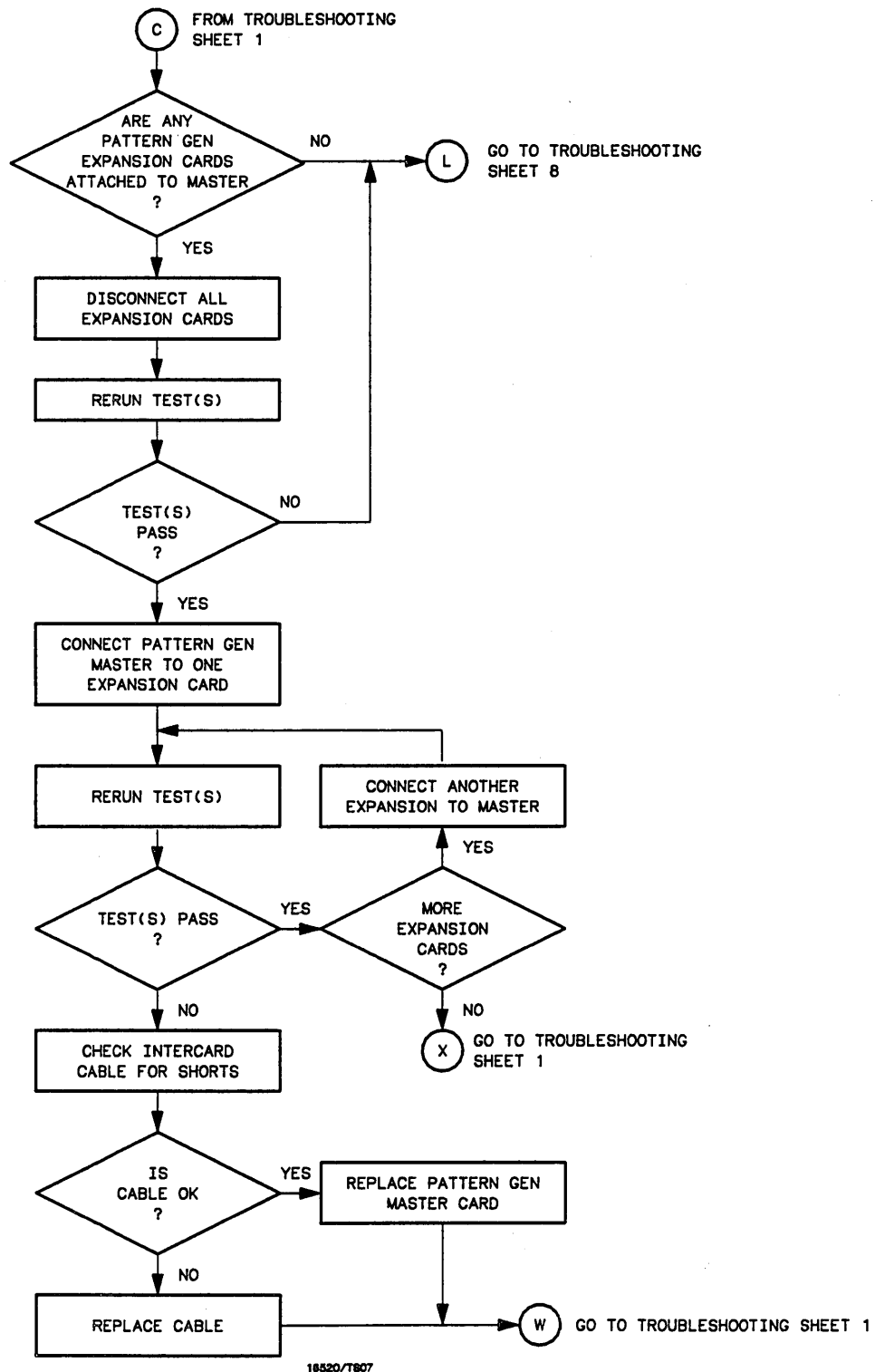

Figure 6-11. Troubleshooting Flow Chart (cont.)

TROUBLESHOOTING SHEET 6

Troubleshooting Sheet 7

TROUBLESHOOTING SHEET 7



16520/T807

Figure 6-11. Troubleshooting Flow Chart (cont.)

Troubleshooting Sheet 8

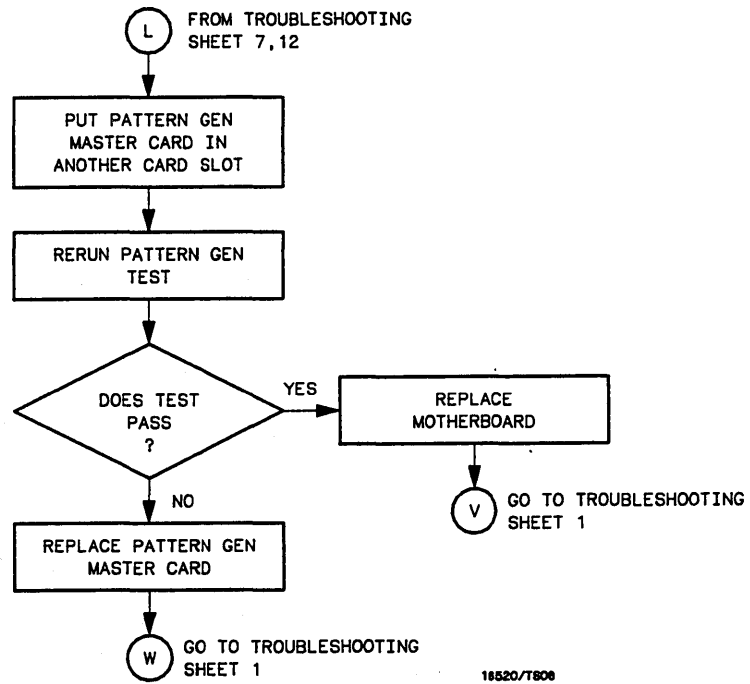

Figure 6-11. Troubleshooting Flow Chart (cont.)

Troubleshooting Sheet 9

TROUBLESHOOTING SHEET 9

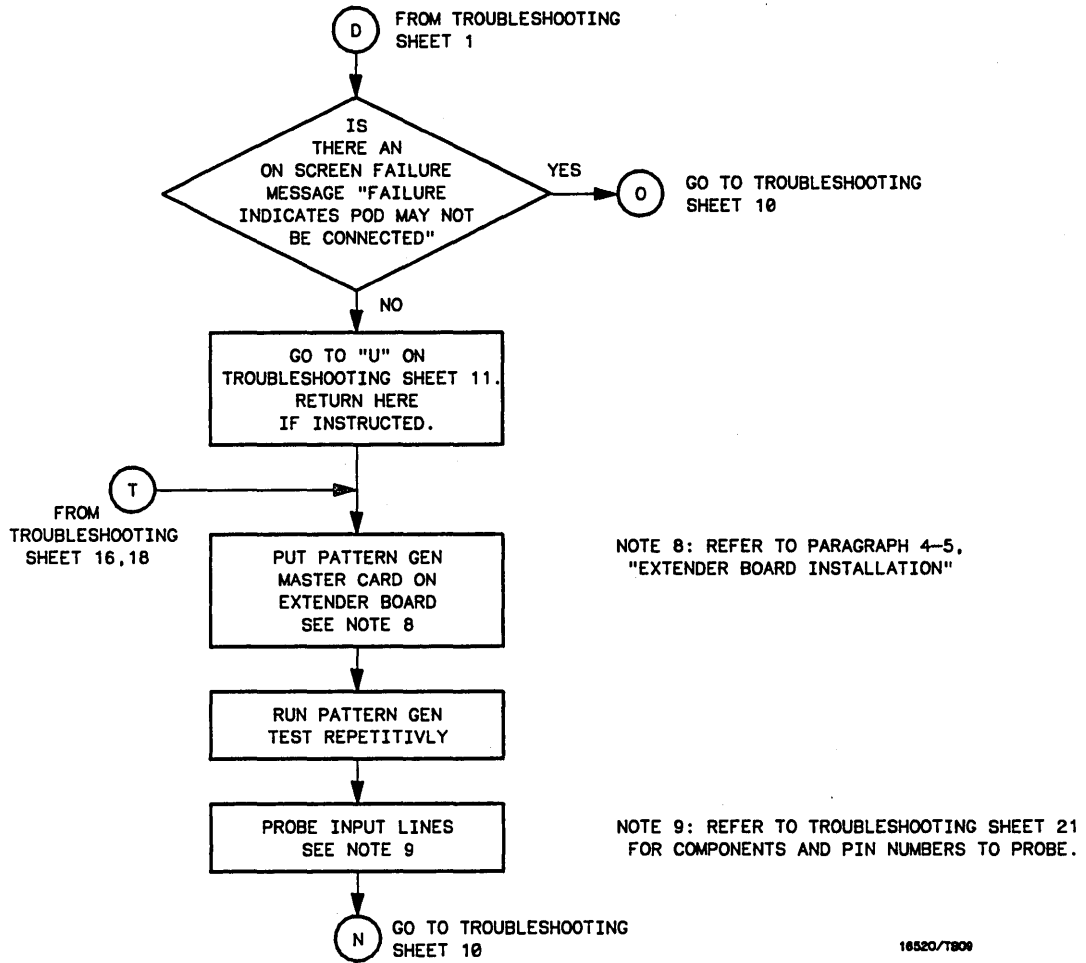
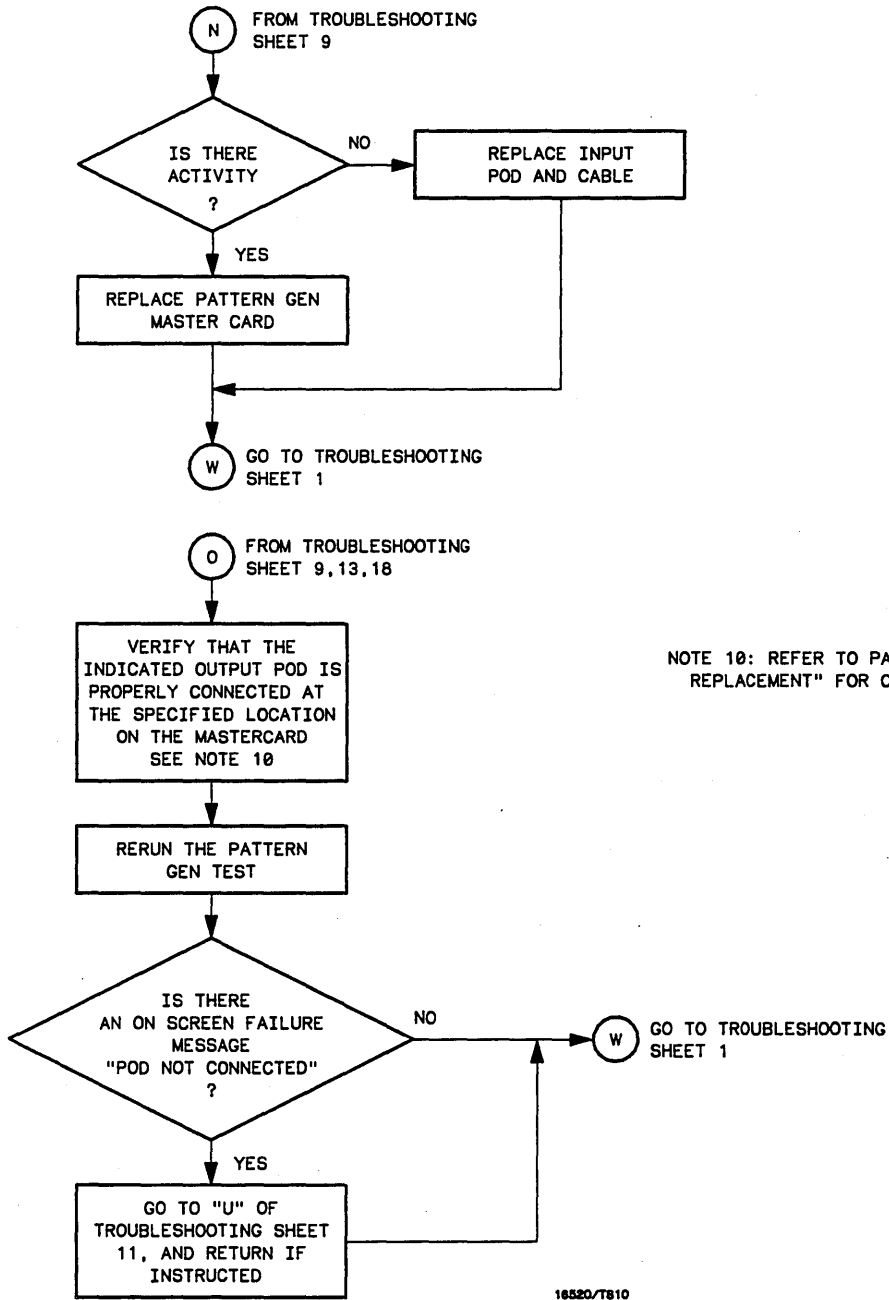

Figure 6-11. Troubleshooting Flow Chart (cont.)

Troubleshooting Sheet 10



TROUBLESHOOTING SHEET 10

Figure 6-11. Troubleshooting Flow Chart (cont.)

Troubleshooting Sheet 11

TRUBLESHOOTING SHEET 11

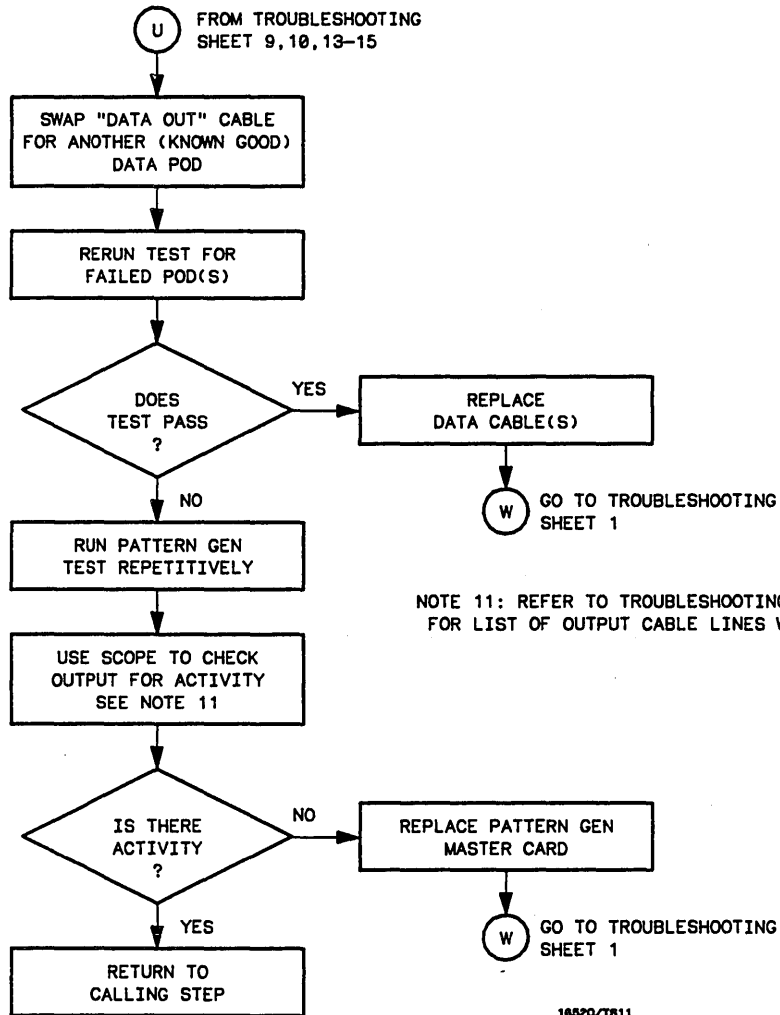

Figure 6-11. Troubleshooting Flow Chart (cont.)

Troubleshooting Sheet 12

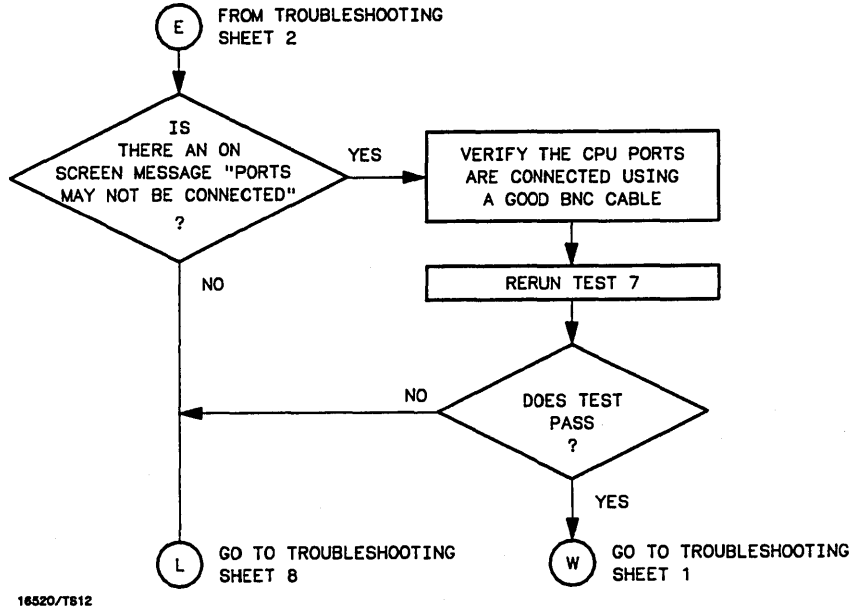

Figure 6-11. Troubleshooting Flow Chart (cont.)

Troubleshooting Sheet 13

TRoubleshooting Sheet 13

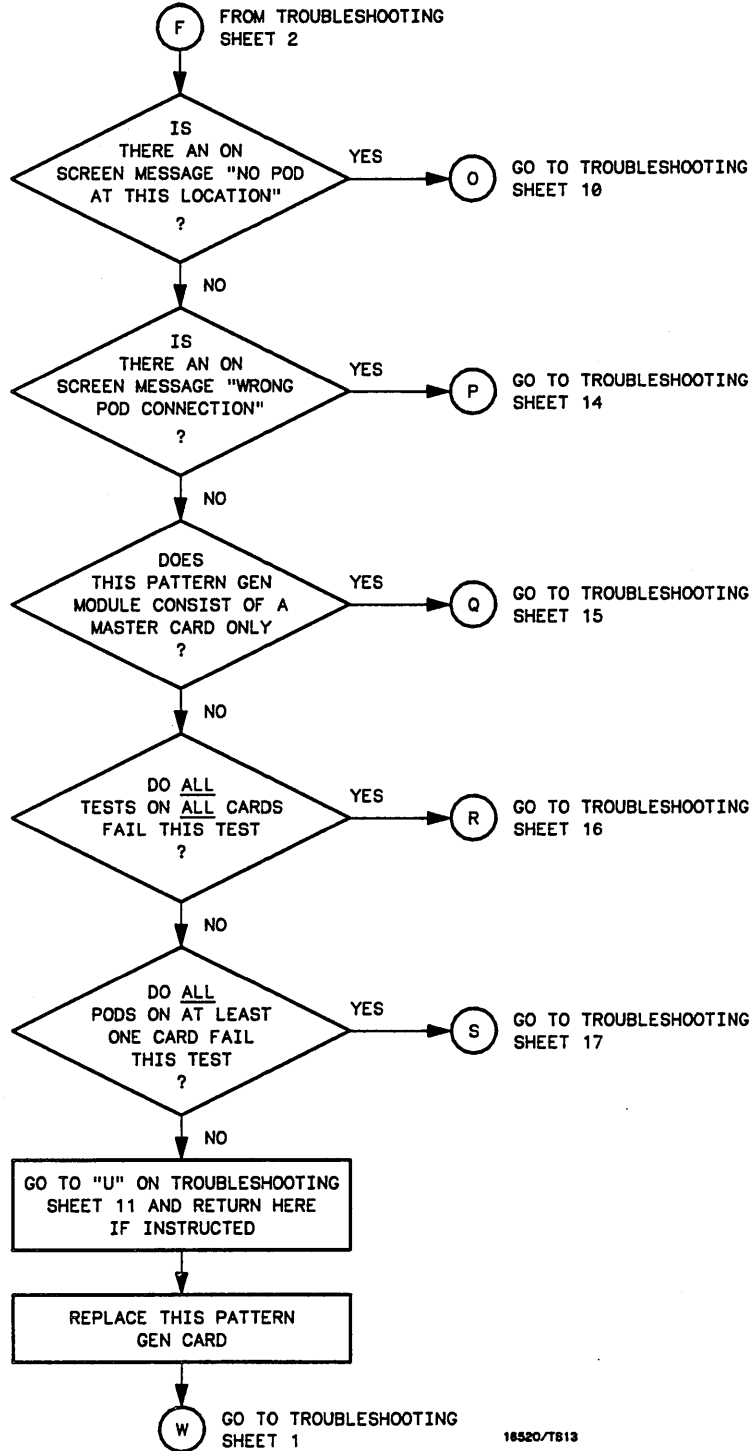
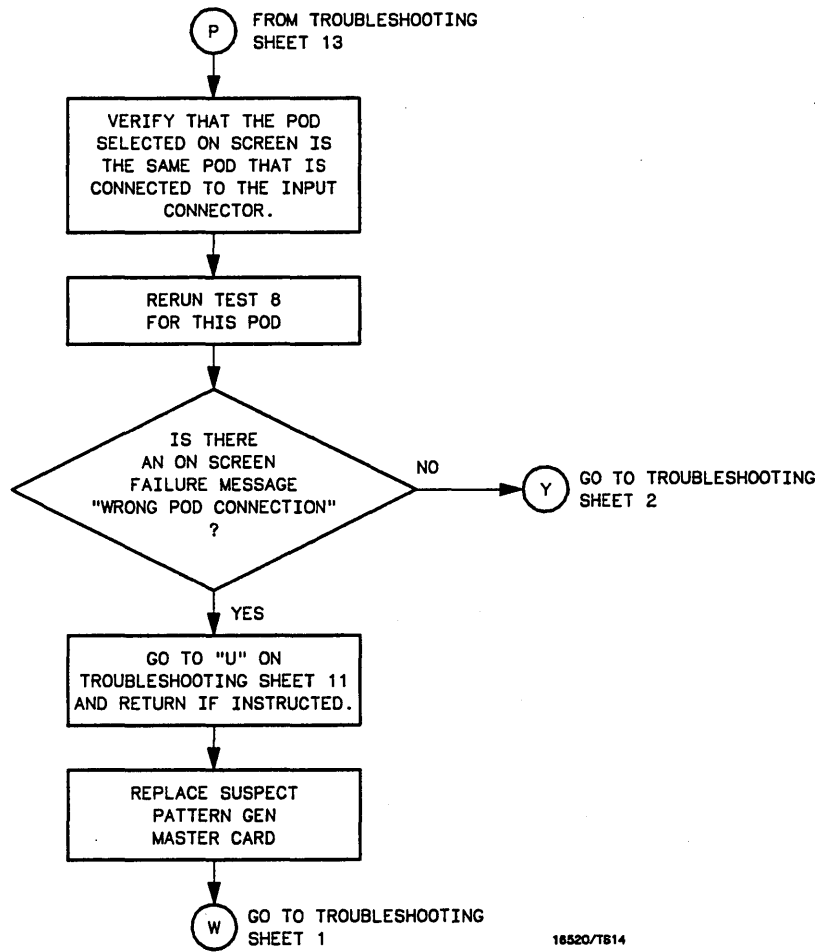

Figure 6-11. Troubleshooting Flow Chart (cont.)

Troubleshooting Sheet 14



16520/TS14

TROUBLESHOOTING SHEET 14

Figure 6-11. Troubleshooting Flow Chart (cont.)

Troubleshooting Sheet 15

TROUBLESHOOTING SHEET 15

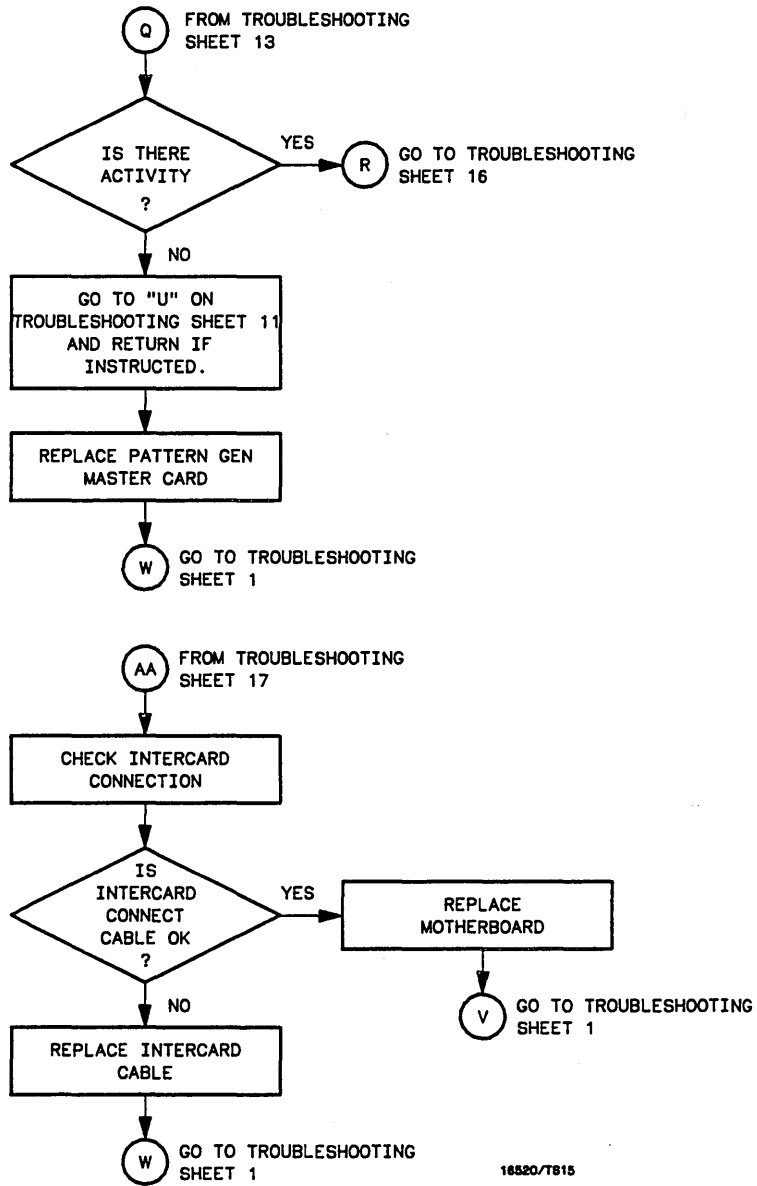

16520/T815

Figure 6-11. Troubleshooting Flow Chart (cont.)

Troubleshooting Sheet 16

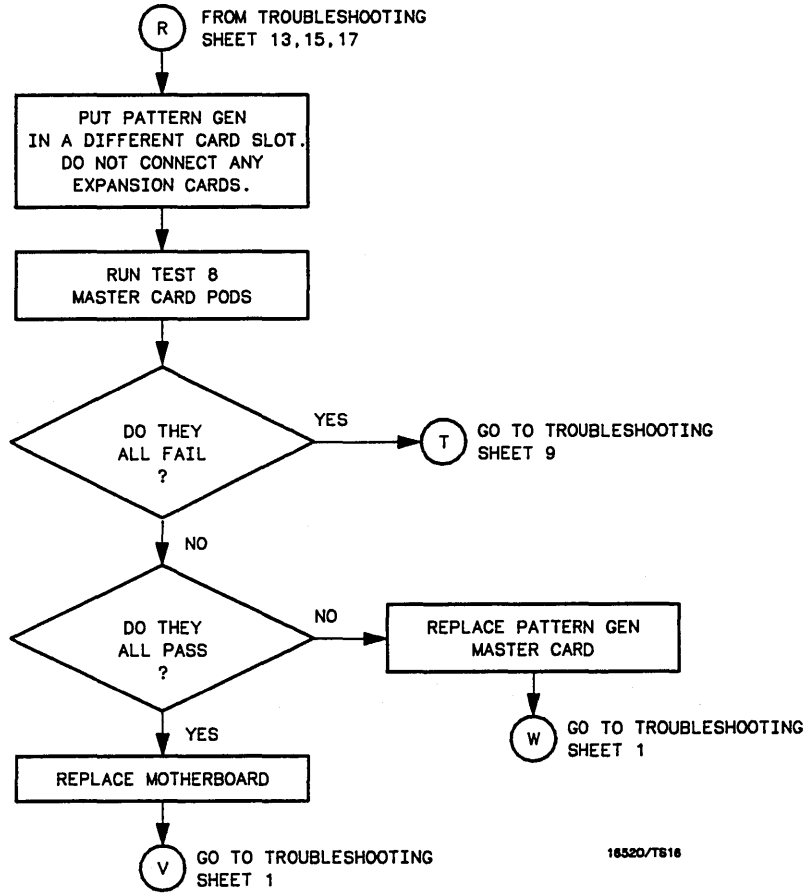
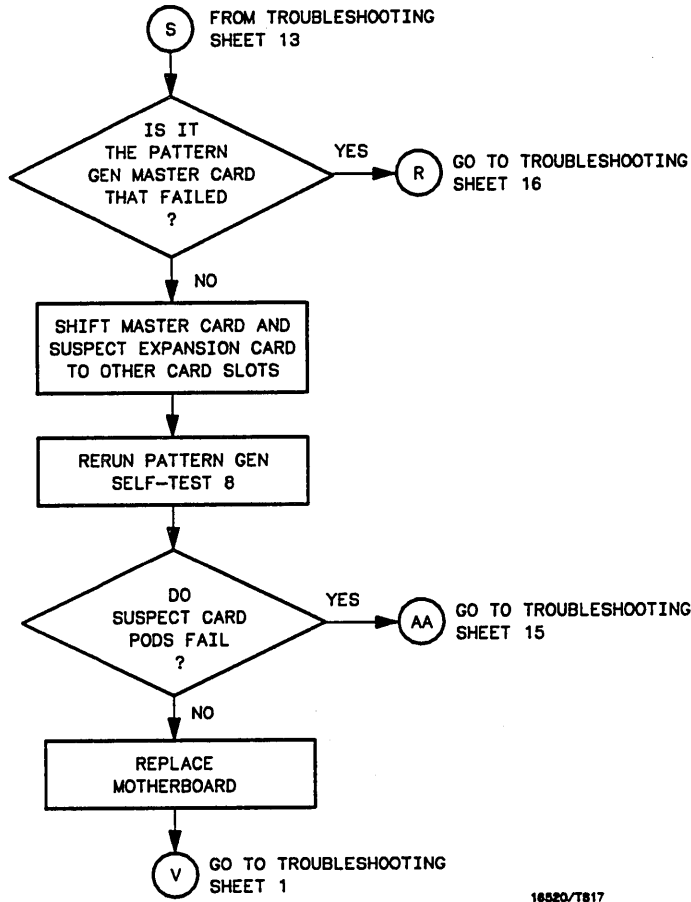

Figure 6-11. Troubleshooting Flow Chart (cont.)

Troubleshooting Sheet 17

TRUBLESHOOTING SHEET 17



16520/7817

Figure 6-11. Troubleshooting Flow Chart (cont.)

Troubleshooting Sheet 18

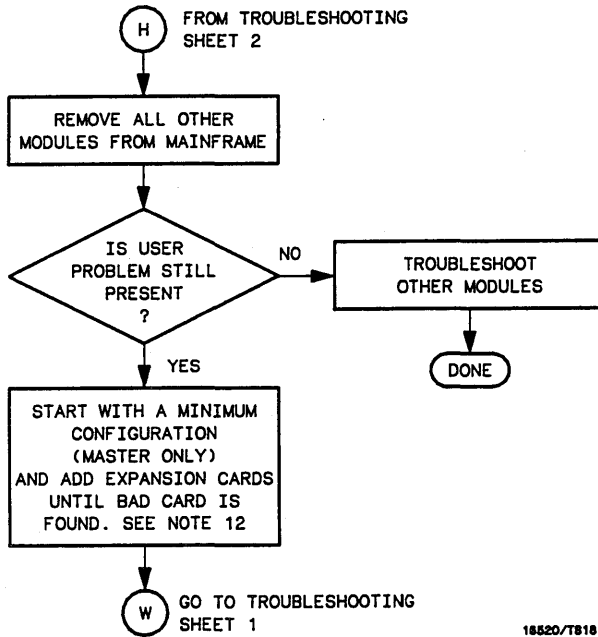
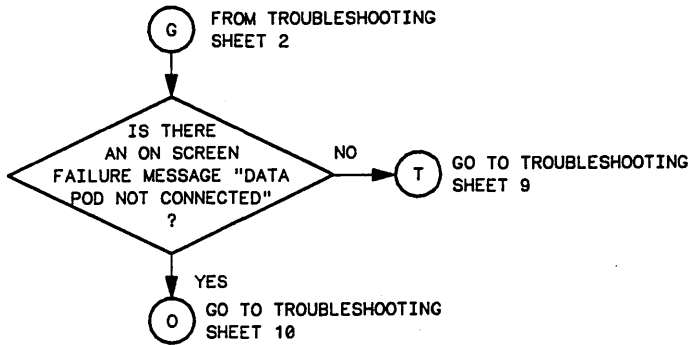

NOTE 12: DURING CARD SWAP, LOOK FOR POSSIBLE MOTHER BOARD PROBLEMS OR INTERCARD CONNECTING CABLE PROBLEMS.

16520/7818

Figure 6-11. Troubleshooting Flow Chart (cont.)

Troubleshooting Sheet 19

NOTE 2: From Troubleshooting Sheet 1

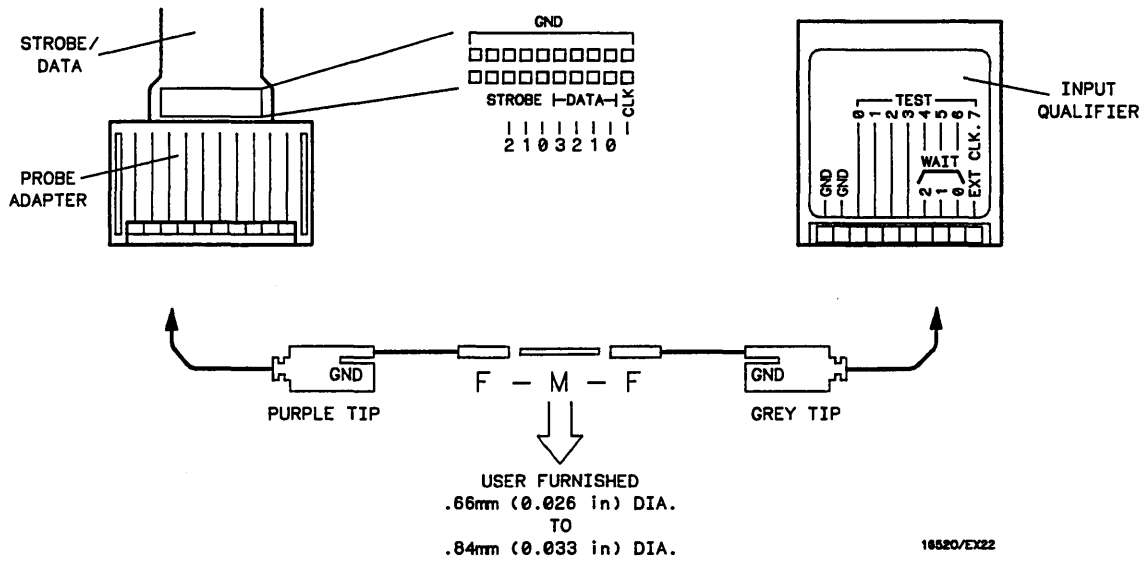

External Connection For Test 6

Use the figure above as a guide for the external connection required in test 6.

STROBE/DATA POD	CONNECTS TO	INPUT QUALIFIER POD
GND	TO	GND
STROBE 2	TO	TEST 4
STROBE 1	TO	TEST 5
STROBE 0	TO	TEST 6

TROUBLESHOOTING SHEET 19

Troubleshooting Sheet 20

NOTE 12: From troubleshooting Sheet 11

Activity For Test 6

You should see activity at ECL or TTL levels on:

Strobe/Data Pod

- CLK
- Strobe 0
- Strobe 1
- Strobe 2

ECL: L= ≤ -1.75V
H= ≥ -0.9V

TTL: L= ≤ +0.8V
H= ≥ +2.0V

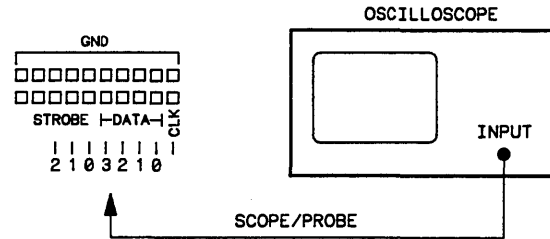

Activity For Test 8 and 9

You should see activity at ECL or TTL levels on:

Strobe/Data Pod

- CLK
- Data 0
- Data 1
- Data 2
- Data 3

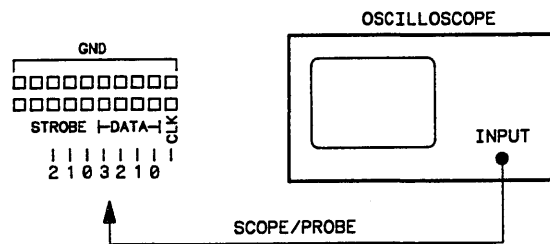

Data Pod

- Data 0
- Data 1
- Data 2
- Data 3
- Data 4
- Data 5
- Data 6
- Data 7

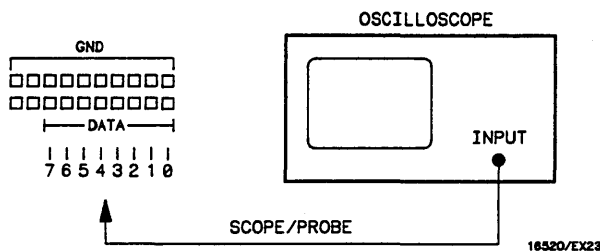

16520/EX23

Troubleshooting Sheet 21

NOTE 9: From Troubleshooting Sheet 9

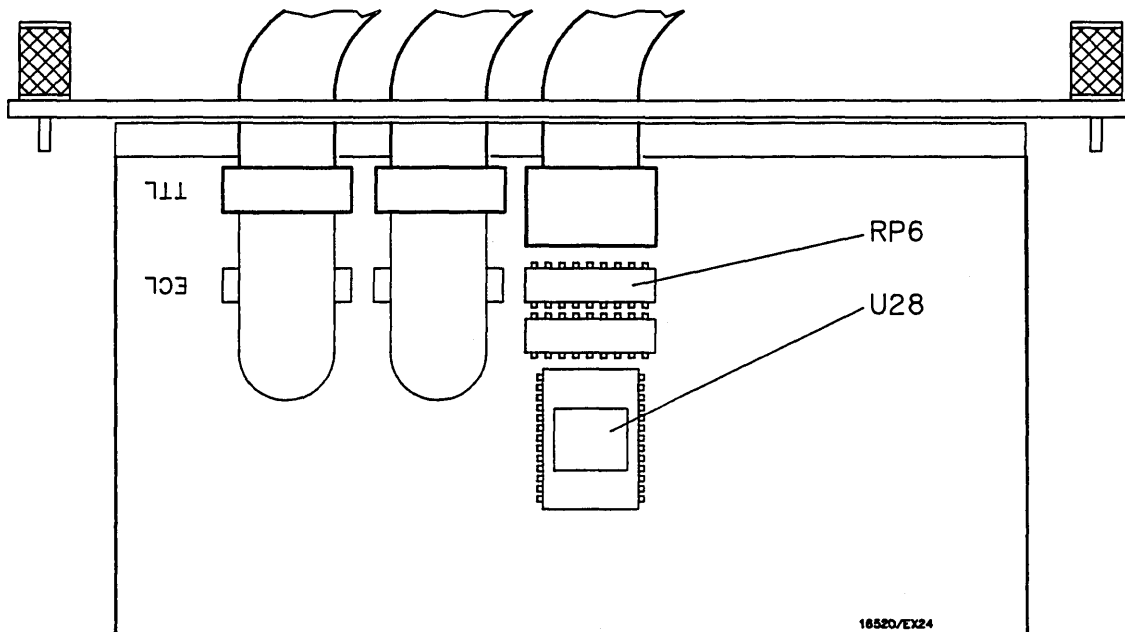

TROUBLESHOOTING SHEET 21

Probe Points For Test 6

First probe **U28**. Activity at ECL levels should be present on pins:

U28

- Pin 26
- Pin 13
- Pin 4

If no activity on U28, probe **RP6** next. RP6 is an alternative point. Activity may be checked at either RP6 or U28.

RP6

- Pin 7
- Pin 6
- Pin 5

ECL: L = $\leq -1.75V$
 H = $\geq -0.9V$

TTL: L = $\leq +0.8V$
 H = $\geq +2.0V$

Troubleshooting Sheet 22

NOTE 4: From Troubleshooting Sheet 2

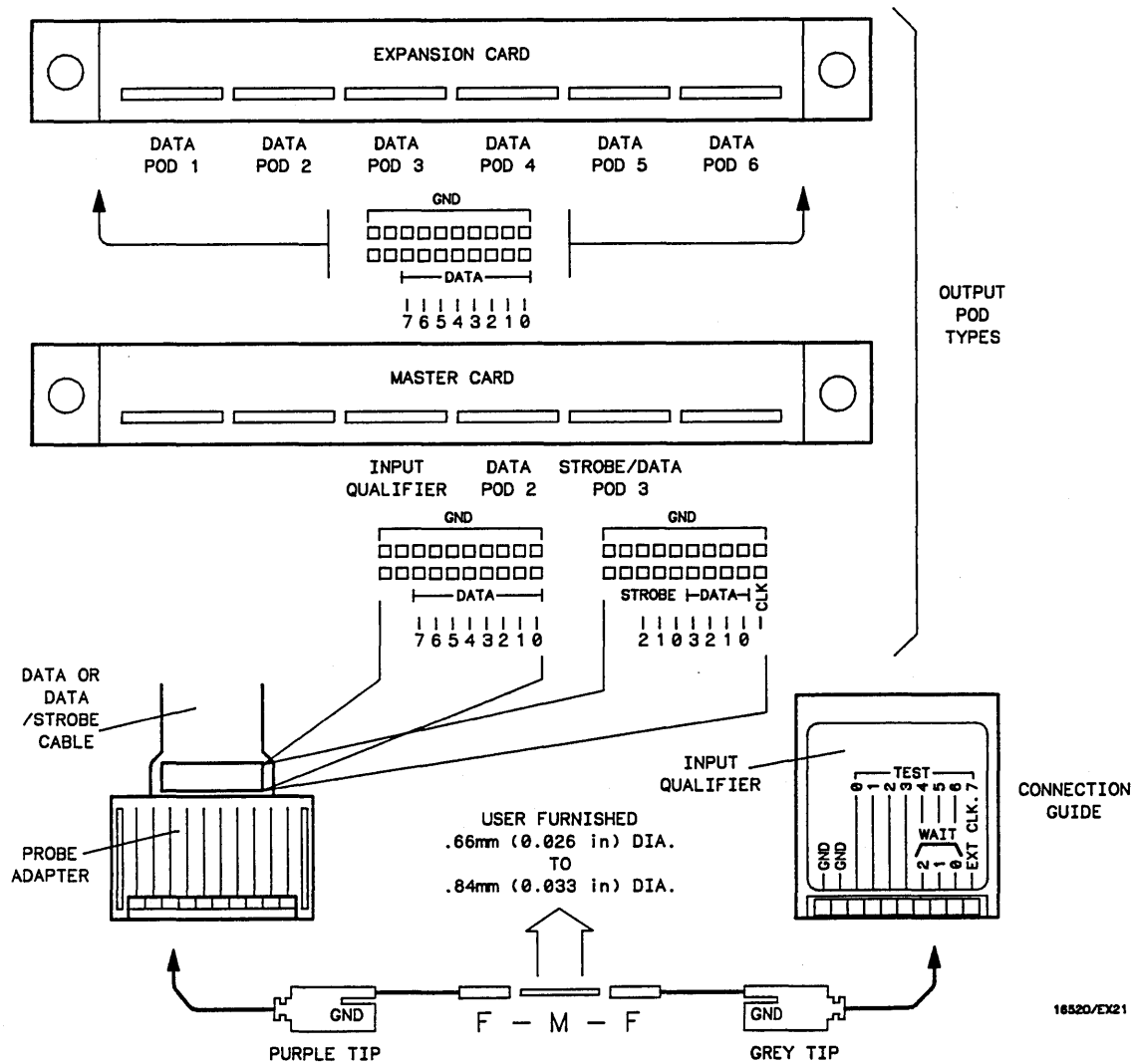

TROUBLESHOOTING SHEET 22

Pod Identification and External Connections For Test 8 and 9

Depending on output pod type being connected, follow the appropriate connection scheme.

STROBE/DATA	OR	DATA POD	CONNECTS TO	INPUT QUALIFIER POD
GND	OR	GND	TO	GND
DATA 0	OR	DATA 0	TO	TEST 0
DATA 1	OR	DATA 1	TO	TEST 1
DATA 2	OR	DATA 2	TO	TEST 2
DATA 3	OR	DATA 3	TO	TEST 3
		DATA 4	TO	TEST 4
		DATA 5	TO	TEST 5
		DATA 6	TO	TEST 6
		DATA 7	TO	TEST 7

6-9. CARD REPLACEMENT

CAUTION

The effects of ELECTROSTATIC DISCHARGE can damage electronic components. Use grounded wriststraps and mats when performing any kind of service to this module.

INSTALLATION CONSIDERATIONS:

- Cards or filler panels below the empty slots intended for the module installation do not have to be removed.
- You will need only one intercard connecting cable for any installation configuration.
- If previously installed modules prevent proper installation, they must be repositioned in the card cage.
- To maintain the channel-to-channel skew and adequate intercard signal quality, the shortest intercard connecting cable should be used and the expansion cards should be no more than two slots away from the master card.

PROCEDURE:

- a. Turn instrument power switch off, unplug power cord and disconnect any input or output connections.
- b. Starting from the top, loosen thumb screws on filler panel(s) and card(s).
- c. Starting from the top, begin pulling card(s) and filler panel(s) out half way. See figure 6-12.

CAUTION

All multi-card modules will be cabled together. Care should be taken to pull these cards out together.

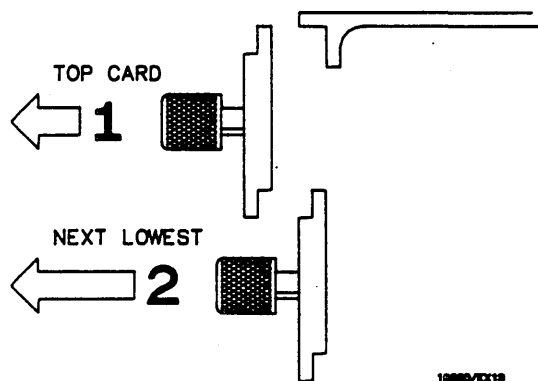

Figure 6-12. Endplate Overlap

- d. Pull all cards in pattern generator module completely out.
- e. Push all other cards into card cage, **but not completely in**. This is to get them out of the way for pattern generator module installation.
- f. Disconnect the cable from all cards in the Pattern Generator Module.
- g. Replace faulty card in module.

Note

If the configuration is changed or help is needed in configuration of the module, refer to step d of paragraph 2-8, "MODULE INSTALLATION". to Plan your configuration.

- h. Insert correct end of appropriate cable into connector on bottom card of configuration. See figure 6-13.
- i. Lay cable flat and pointing out to the rear of card. See figure 6-14.

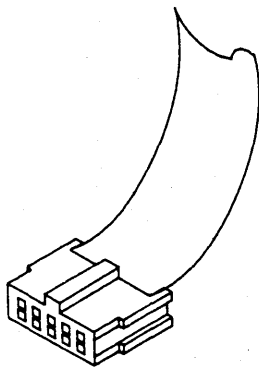

CABLE & KEY
ON SAME SIDE

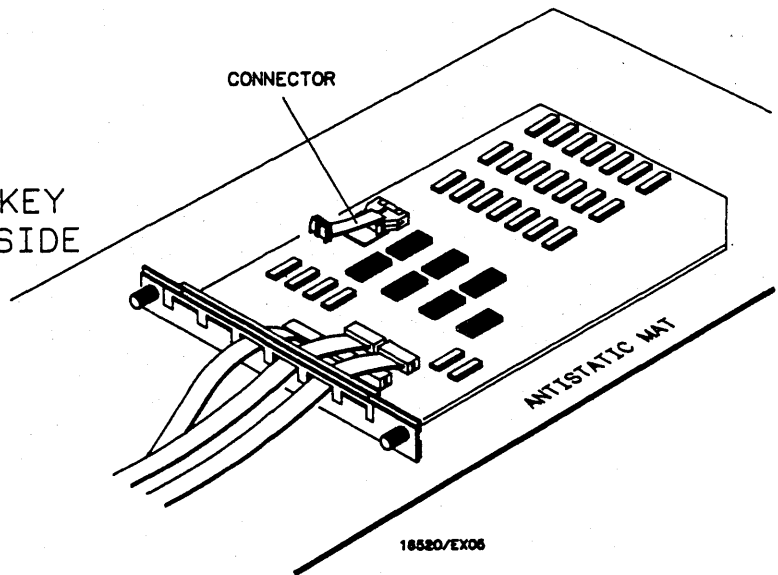

Figure 6-13. Cable End

Figure 6-14. Cable Position

- j. Slide card approximately half way into lowest of slots that you are using.
- k. Slide next card half way into next highest slot feeding cable up through the hole.
- l. Insert appropriate cable end into card.
- m. If there are more cards to install, repeat steps k and l, until all cards are in place.

- n. Firmly seat bottom card into backplane connector. **Keep applying pressure to the center of card endplate while tightening thumb screws finger tight.**
- o. Repeat for all cards and filler panels in a **bottom to top** order. See figure 6-15.

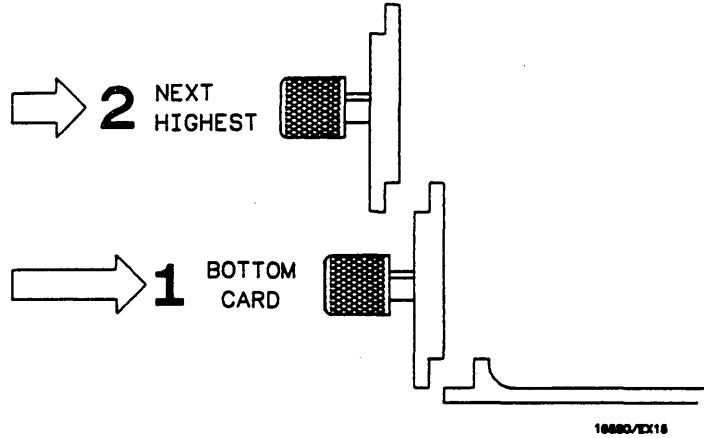

Figure 6-15. Endplate Overlap

- p. Any filler panels that are not used should be kept for future use. Filler panels **must** be installed in all unused card slots for correct air circulation.

6-10. PROBE CABLE REPLACEMENT

CAUTION

The effects of ELECTROSTATIC DISCHARGE can damage electronic components. Use grounded wriststraps and mats when performing any kind of service to this instrument or the cards in it.

PROCEDURE:

- a. Turn the instrument power switch off, unplug power cord and disconnect any input or output connections.
- b. Starting from the top, loosen thumb screws on all filler panel(s) and card(s).
- c. Starting from the top, begin pulling all filler panel(s) and card(s) out half way. See figure 6-16.

CAUTION

All multi-card modules will be cabled together. Care should be taken to pull these cards out together.

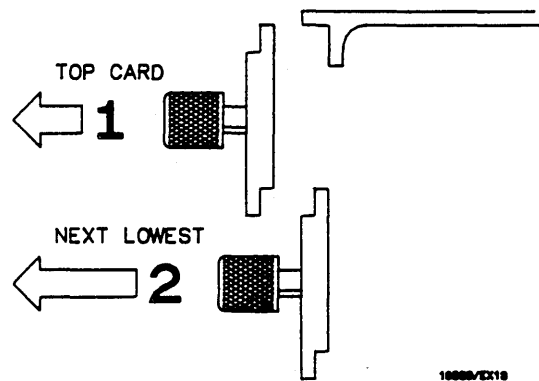

Figure 6-16. Endplate Overhang

- d. Pull HP 16520/21A Module to be serviced completely out.

- e. Lay card on antistatic mat with cable(s) flat and pointing out to rear of card. See figure 6-17.

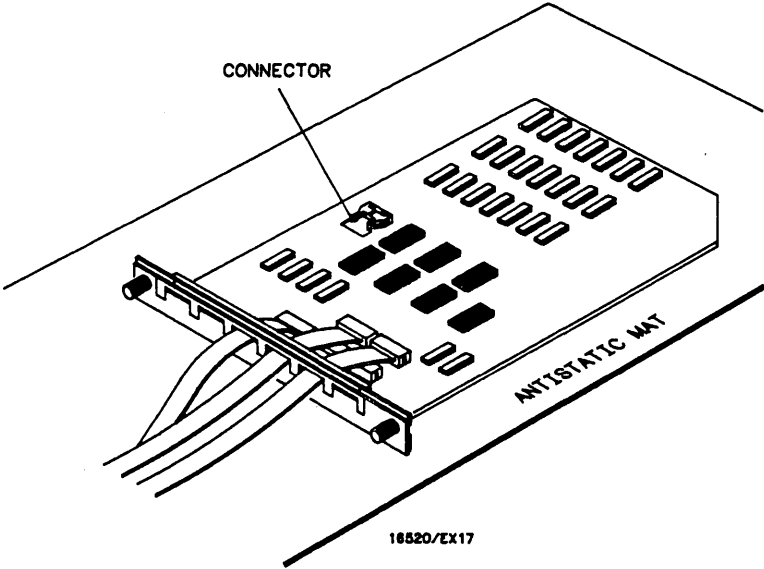

Figure 6-17. Card On Antistatic Mat

- f. Using a No. 10 torx Ⓢ driver, remove four screws that hold cable retainer onto card. See figure 6-18.

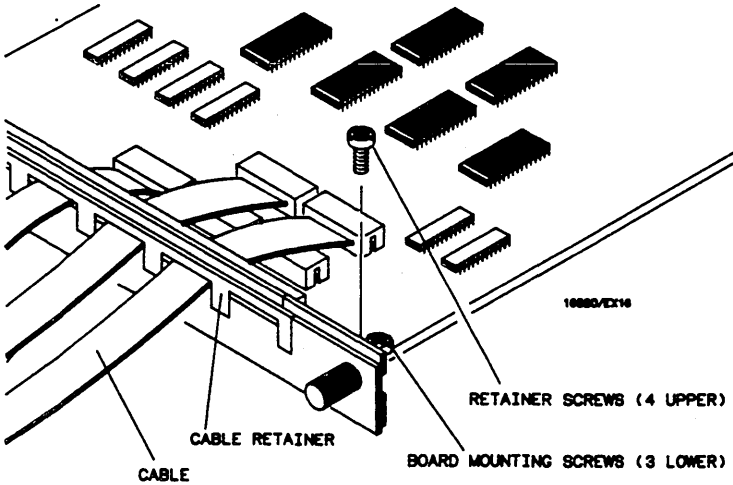

Figure 6-18. Retainer And Screws

- g. Remove cable(s) from card connector(s) and install new cable(s). See figure 6-19.

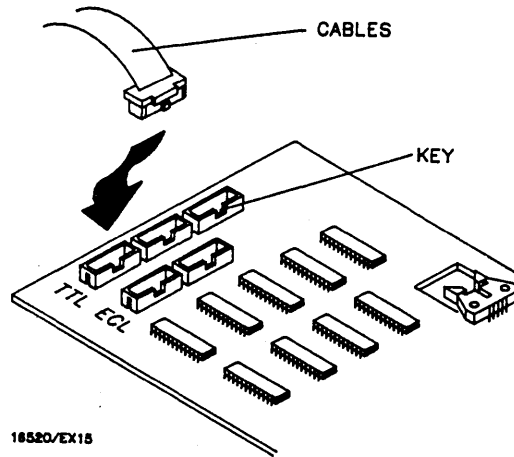

Figure 6-19. Card Connectors

- h. Install cable retainer.
- i. At this point go to step d of paragraph 2-8, "MODULE INSTALLATION", and continue installation of cards.

